

**INSTRUCTION
MANUAL**

ATyS *t* M

Automatic Transfer Switching Equipment

EN





www.socomec.com

www.socomec.com/en/atys-t-m

To download, brochures, catalogues and technical manuals :

This manual is available for download in French, English, German, Italian, Spanish, Dutch, Portuguese, Russian, Polish, Turkish and Chinese.

INDEX

1. GENERAL SAFETY INSTRUCTIONS	6
2. INTRODUCTION	7
2.1. THE ATYS FAMILY PRODUCT RANGE	7
2.2. THE ATYS M RANGE KEY FEATURES	8
2.2.1. SELECTION GUIDE	9
3. QUICK START	10
3.1. QUICK START ATYS T M	10
4. ATYS T M VERSIONS	12
4.1. PRODUCT PRESENTATION	12
4.2. SPECIFICATIONS AND ADVANTAGES	12
4.3. SUPPLY TYPES	12
5. OPTIONAL ACCESSORIES	13
6. TECHNICAL DATA	14
7. ENVIRONMENTAL CONDITIONS	15
8. PRODUCT INSTALLATION	16
8.1. CHANGING THE PADLOCKING CONFIGURATION	16
8.2. RECOMMENDED ORIENTATION	16
8.3. DIMENSIONS	16
8.4. BACK PLATE MOUNTED	16
8.5. DIN RAIL MOUNTED	17
9. INSTALLATION OF OPTIONAL ACCESSORIES	18
9.1. AUXILLIARY CONTACTS	18
9.2. VOLTAGE SENSING AND POWER SUPPLY TAP	18
9.3. BRIDGING BARS 4P	18
9.4. TERMINAL SHROUDS	19
9.5. SEALABLE COVER	19
10. INSTALLING WITHIN THE ATYS M ENCLOSURE	20
10.1. POLYCARBONATE ENCLOSURE	20
10.1.1. WIRING IN A POLYCARBONATE ENCLOSURE	20
10.1.2. EXTENSION UNIT	20
11. CONNECTION OF THE POWER CIRCUITS	21

11.1. RATINGS / CROSS-SECTIONS TABLE OF CORRESPONDENCE	21
11.2. PARALLEL POLE SET-UP FOR A 4P DEVICE USED IN SINGLE PHASE	21
11.3. NETWORK CONFIGURATIONS	22
11.3.1. THREE PHASE WITHOUT NEUTRAL NETWORK	22
12. CONNECTION OF CONTROL/COMMAND CIRCUITS.....	23
12.1. TERMINAL CONNECTORS DESIGNATION	24
12.2. AUXILIARY CONTACT OPERATING SCHEDULE	25
13. OPERATION.....	26
13.1. PRESENTATION OF THE PRODUCT INTERFACE	26
13.1.1. PRODUCT INTERFACE	26
13.1.2. RESET.....	26
13.2. MANUAL MODE	27
13.2.1. MANUAL SWITCHING.....	27
13.3. PADLOCKING	27
13.4. PROGRAMMING	28
13.4.1. AUTO-CONFIGURATION.....	28
13.4.2. SEALABLE CONFIGURATION COVER	29
13.5. AUTOMATIC MODE.....	29
13.5.1. SEALABLE AUTO/MANUAL COVER.....	29
13.6. POSSIBLE ACTIONS.....	29
14. PREVENTATIVE MAINTENANCE	30
15. TROUBLESHOOTING GUIDE	30

This page intentionally left blank

1. GENERAL SAFETY INSTRUCTIONS

- This manual provides instructions on safety, connections and operation of the ATyS M transfer switch manufactured by SOCOMEC.
- Whether the ATyS is sold as a loose product, as a spare, as an enclosed solution or as any other configuration, this device must always be installed and commissioned by qualified and experienced personnel, in line with the manufacturers recommendations, following good engineering practices and after having read and understood the details in the latest release of the relative product instruction manual.
- Maintenance on the product and any other associated equipment including but not limited to servicing operations must be performed by adequately trained and qualified personnel.
- Each product is shipped with a label or other form of marking including rating and other important specific product information. One must also refer to and respect markings on the product prior to installation and commissioning for values and limits specific to that product.
- Using the product outside the intended scope, outside SOCOMEC recommendations or outside the specified ratings and limits can cause personal injury and/or damage to equipment.
- This instruction manual must be made accessible so as to be easily available to anyone who may need to read it in relation with the ATyS.
- The ATyS meets the European Directives governing this type of product and includes CE marking on each product.
- No covers other than that for auto/manu on the ATyS should be opened (with or without voltage) as there may still be dangerous voltages inside the product such as those from external circuits.
- **Do not handle any control or power cables connected to the ATyS when voltage may be present on the product directly through the mains or indirectly through external circuits.**
- Voltages associated with this product may cause injury, electric shock, burns or death. Prior to carry out any maintenance or other work on live parts or other parts in the vicinity of exposed live parts, ensure that the switch including all control and associated circuits are de-energized.

 DANGER	 WARNING	 CAUTION
RISK: Electric shock, burns, death	RISK: Possible personal injury	RISK: Equipment damage

- As a minimum the ATyS M comply with the following international standards:
 - IEC 60947-6-1
 - GB 14048-11
 - EN 60947-6-1
 - VDE 0660-107
 - BS EN 60947-6-1
 - NBN EN 60947-6-1
 - IEC 60947-3
 - IS 13947-3
 - EN 60947-3
 - NBN EN 60947-3
 - BS EN 60947-3

The information provided in this instruction manual is subject to change without notice, remains for general information only and is non-contractual.

2. INTRODUCTION

ATyS t M “Automatic Transfer Switching Equipment” (ATSE) is designed for use in power systems for the safe transfer of a load supply between a normal and an alternate source. The changeover is done in open transition and with minimum supply interruption during transfer ensuring full compliance with IEC 60947-6-1, GB 14048-11 and other international TSE standards as listed.

The ATyS t M is a full load break (switch type) derived transfer switching equipment where the main components are proven technology devices also fulfilling requirements in IEC 60947-3 standards.



As a Class PC ATSE, the ATyS t M is capable of “making and withstanding short circuit currents” assigned to IEC 60947-3 utilization categories of up to AC23A, GB 14048-11, IEC 60947-6-1 and equivalent standards with utilization categories of up to AC33B.

ATyS t M transfer switches ensure:

- Power Control and Safety between a normal and an alternate source.
- A complete product delivered as a fully assembled and tested solution.
- Intuitive HMI for emergency / local operation.
- Integrated and robust switch disconnection.
- Window with clearly visible position indication I – 0 - II.
- An inherent failsafe mechanical interlock.
- Stable positions (I – 0 – II) non affected by typical vibration and shocks.
- Constant pressure on the contacts non affected by network voltage.
- Energy Efficient with virtually no consumption whilst on the normal, alternate or off positions.
- Extremely rugged, error free and built in padlocking facility (configurable).
- Straight forward installation with effective ergonomics.
- Simple motorization control interface.
- ATS configuration through 4 potentiometers and DIP switches.
- Auxiliary contacts for switch positions I – 0 - II (optional).
- “Product availability” output.
- Ample accessories to suit specific requirements.
- Fully integrated ATS controller specifically designed for Mains / Mains and Mains / Genset applications.

2.1. The ATyS family product range

Just the right ATyS for your application...

ATyS: Small Footprint	ATyS M: Modular Profile
Back to Back Configuration	
	ATyS p M Power/Genset Management
ATyS d S Small Genset with DPS	ATyS g M Simple Genset Management
ATyS S (RTSE) Small Genset	ATyS t M Transformer (building) Management
ATyS r ⁽¹⁾ ATyS  RTSE	ATyS d M RTSE (DPS)
ATyS d RTSE (DPS)	Side by Side Configuration
ATyS t Transformer Management	
ATyS g Simple Genset Management	
ATyS p Power/Genset Management	

⁽¹⁾ The UL version of ATyS r is available from 100 - 400A

2.2. The ATyS M Range Key Features

Selecting the right ATyS M will depend on the application, the functionality required as well as the nature of the installation in which the ATyS M will be installed. Below is an outline product selection chart listing the key features of each product to help you select the right ATyS M for your needs.

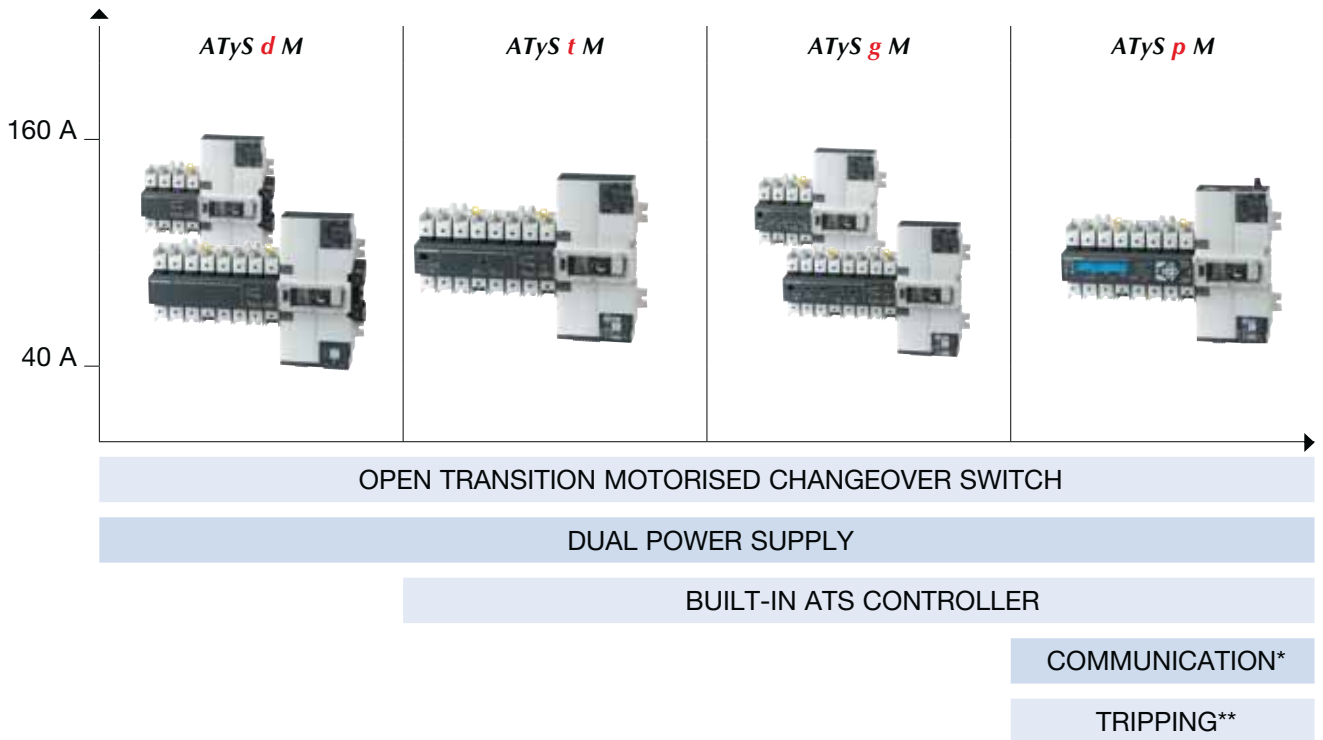

* Specific version. ** Return to zero without external energy source.

A product for virtually all power changeover applications from 40 to 160 A

- > Network/Genset
 - > Genset/Genset
 - > Network/Network
- Applications with an External ATS Control

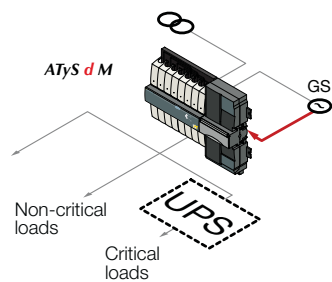

- > Network/Network
- Building applications

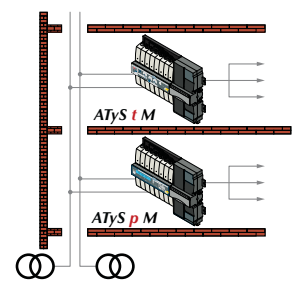

- > Network/Genset
- Genset Applications for Standby Power

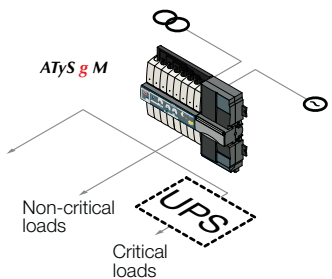

- > Network/Genset
- > Network/Network

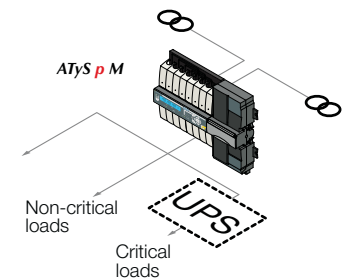

2.2.1. Selection guide

Six ratings 40/63/80/100/125/160 A

	ATyS <i>d</i> M	ATyS <i>t</i> M	ATyS <i>g</i> M	ATyS <i>p</i> M
APPLICATIONS				
Normal/Backup without automatic controller	•			
Normal/Backup with built-in automatic controller		•	•	•
Stable positions	•	•	•	•
Load changeover	•			
FUNCTIONS				
POWER SUPPLY				
External	•			
Integrated		•	•	•
OPERATION				
Backup manual operation of the 3 positions	•	•	•	•
Electrical (dry contact) control of positions I, 0 and II	•			•*
Automatic control of positions I, 0 and II		•	•	•
Return to 0 position feature upon loss of source				•
MONITORING				
3 voltages on networks I and II		•	•	•
Frequency on networks I and II		•	•	•
Phase rotation on networks I and II				•
Asymmetry of networks I and II				•
AUTOMATIC CONTROLLER CONFIGURATION				
By potentiometer and micro-switch		•	•	
By screen + keyboard				•
V _n , F _n , V threshold, F threshold		•	•	•
Driving with or without priority		•	•	•
Adjustable operating timers		•	•	•
Control type (impulse or switch/contactor)	•			
DISPLAY				
Position, fully visualised breaking	•	•	•	•
LED: source status, automatic mode, fault LED		•	•	•
LED: switch positions, supply, tests, control				•
V, F, timers, number of operations, last event				•
REMOTE CONTROL				
Outputs				
Generator start/stop order			•	•
Product availability (not fault and not manual mode)			•	•*
Source available		•		•*
Programmable output (source, availability, fault)				•*
Inputs				
Test on load			•	•*
Retransfer			•	•*
Automatic mode inhibit		•	•	•*
Position 0 order		•		•*
Priority		•	•	•
Other programmable inputs (test off-load, position control, etc.)				•*
Remote control				
Human/Machine Interface (<i>D10</i> and <i>D20</i>)				•
RS485 communication (MODBUS)				•**

* 3 inputs/3 outputs (programmable).

** Product reference is different: communication by RS485 connection (MODBUS) allows up to 31 ATyS M to be connected to a PC or a PLC over 1500 m.

3. QUICK START

3.1. Quick Start ATyS t M



QUICK START EN 40 - 160A (4P)

ATyS t M

Automatic Transfer Switching Equipment

Preliminary operations

Check the following upon delivery and after removal of the packaging:

- Packaging and contents are in good condition.
- The product reference corresponds to the order.
- Contents should include:
 - Qty 1 x ATyS M
 - Qty 1 x Emergency handle extension rod
 - Qty 1 x Set of terminals
 - Quick Start instruction sheet

Warning

⚠ Risk of electrocution, burns or injury to persons and / or damage to equipment.

This Quick Start is intended for personnel trained in the installation and commissioning of this product. For further details refer to the product instruction manual available on the SOCOMEC website.

- This product must always be installed and commissioned by qualified and approved personnel.
- Maintenance and servicing operations should be performed by trained and authorised personnel.
- Do not handle any control or power cables connected to the product when voltage may be, or may become present on the product, directly through the mains or indirectly through external circuits.
- Always use an appropriate voltage detection device to confirm the absence of voltage.
- Ensure that no metal objects are allowed to fall in the cabinet (risk of electrical arcing).

Failure to observe good engineering practises as well as to follow these safety instructions may expose the user and others to serious injury or death.

⚠ Risk of damaging the device

- In case the product is dropped or damaged in any way it is recommended to replace the complete product.

Accessories

- Bridging bars 125A or 160A.
- Control voltage transformer (400Vac -> 230Vac).
- Voltage sensing and power supply tap.
- Terminal shrouds.
- Auxilliary contact blocks.
- Polycarbonate enclosure.
- Polycarbonate extension box.
- Power Connection Terminals.
- Sealable cover.



www.socomec.com
www.socomec.com/en/atys-t-m

To download, brochures, catalogues and technical manuals.
Printing informations: 1 color Black. White paper 90g/m².
Printing size: 420x297. Final size 210x297. This page visible first.
A separate sheet for each language.



542 930 B - 06/14 - EN Non contractual document. Subject to change without notice.

Installation and Commissioning

STEP 1
Cabinet / Back Plate Installation

STEP 2
Connecting the POWER section

STEP 3
CONTROL / AUX POWER terminal connections

STEP 4
CHECK

STEP 5
Programming

STEP 6A
Automatic Operation

STEP 6B
Emergency Manual Operation

STEP 6C
Padlocking

STEP 6A *Automatic operation*

Close the front cover as shown to put the product into automatic mode.

STEP 6B *Manual operation*

- Open the front cover as shown to put into manual mode.
- Use the handle situated in the front panel under the cover to operate the transfer switch.
- Check the changeover switch position on the indicator before operating.

To simplify operation use the handle with the extension provided.

(Max 8 Nm)

STEP 4 *Check*

Whilst in manual mode, check the wiring and if ok power up the product.

STEP 5 *Programming*

■ Auto conf. of the network voltage and frequency.

Setting mode A-B

- A: Ready
- B: Auto Conf (Auto-configuration)

1. Put dipswitch A-B to position B. (All Led's should be blinking).
2. When the LED's become a steady light ON, configuration of the network is ready.
3. Put dipswitch A-B back to A.

A: Ready E:

B: Auto Conf F:

C: ΔU/ΔF 10% G: Priority

D: ΔU/ΔF 20% H: Priority

■ Set dip switches C-D, E-F, G-H

Thresholds C-D

- C: ΔU 10%/ΔF 5%
- D: ΔU 20%/ΔF 10%

Stop in 0 position E-F

- E: No stop in 0 position
- F: 2s stop in 0 position

Priority G-H

- G: With priority
- H: Without priority

STEP 6C *Padlocking mode*

- In order to padlock put the product in manual mode.
- Pull the locking mechanism and insert a padlock as shown.
- As standard padlocking in the 0 position. Configurable to I-0-II (see step 1).

1x 4-8 mm

10 EN

ATyS t M - 542 931 A - SOCOMEC

STEP 1

Installation

Caution: Ensure that the product is installed on a flat rigid surface.

Recommended orientation

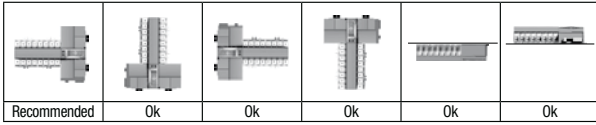

Recommended Ok Ok Ok Ok Ok

DIN RAIL
IEC 60715

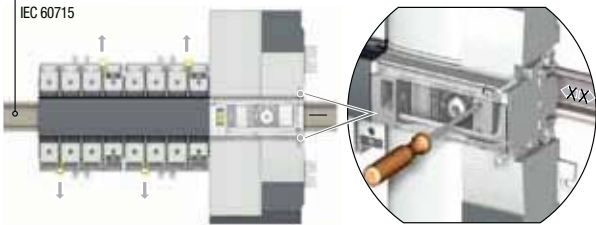

Tighten to avoid movement on the DIN rail.

Posidriv PZ1
1 Nm

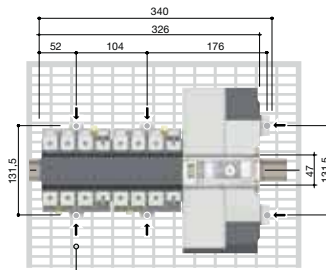
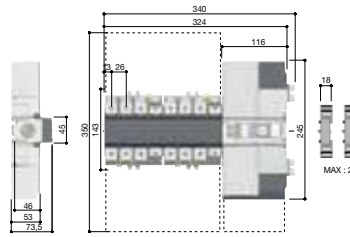

6 mounting brackets
6x M6 screw - 2,5 Nm

Padlocking configuration

The ATyS M is delivered with padlocking configured to the 0 position.

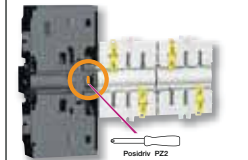
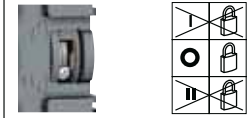

To allow padlocking in all positions (I - 0 - II), configure the ATyS M as follows before installation. (Screw is located at the back of the product).

STEP 2

Power Terminal Connections

It is essential to tighten all terminals including those not being used.



Source supply side

Load side
bridging bar.
125A: 1309 4006
160A: 1309 4016



Hexagonal Metric
Allen size 4
5,0 Nm

10 to 70 mm²
[15mm]

Voltage taps provide 2x ≤ 1.5mm² connections. They can be fitted in any terminals on the source supply side. Do not use on the load side when equipped with a bridging bar.

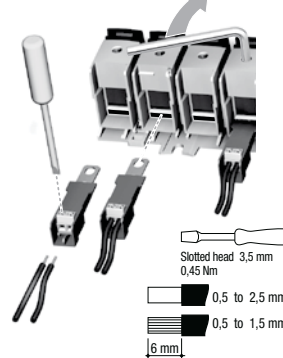

Slotted head 3,5 mm
0,45 Nm

0,5 to 2,5 mm²

0,5 to 1,5 mm²

[6 mm]

Step 1

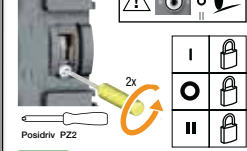

Step 2



Step 3

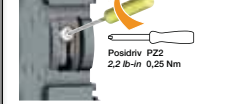

NTROL / AUX POWER Terminals and wiring

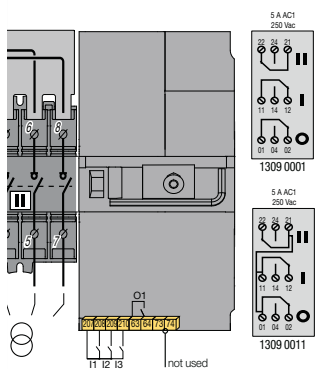

Type	Terminal no.	Description	Characteristics	Recommended connection cross-section
Inputs	207	Common	Do not connect to any power supply	0,5 to 2,5 mm ² (rigid)
	208	Position 0 order		
	209	Open S1 priority. Closed S2 priority.		
	210	Inhibition ATS		
Outputs	63/64	Open: S1 and S2 NOT available. Closed: S1 or S2 available	0,5 to 1,5 mm ² (stranded)	
	73/74	Not used		
	Auxiliary contacts unit.	11/12/14 21/22/24 01/02/04		Dry potential free contact 250Vac 5A AC1 24Vdc 2A

Ensure that the product is in Manual Mode (front cover open).

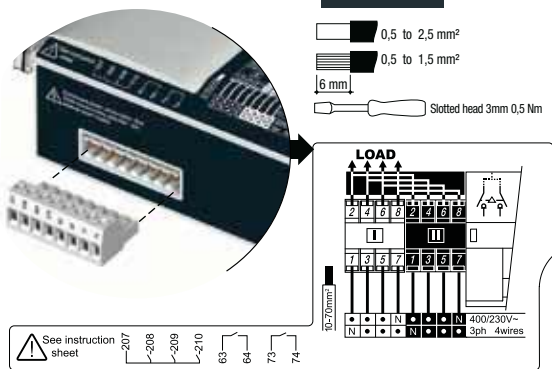

0,5 to 2,5 mm²

0,5 to 1,5 mm²

[6 mm]

Slotted head 3mm 0,5 Nm

See instruction sheet

Auxiliary contacts: Fitting of auxiliary contacts: 1309 0001 or 1309 0011
To fit an AC, the switch must first be put in position 0. An auxiliary contact module comprises: one NO/NC changeover contact for each position (I-0-II). To install use the long screws supplied with the module.

Set potentiometer for priority supply "Failure and Return Timer"
FT: 0-30 sec / RT: 0-30 min.



Source availability LED's

Source	I	II
LED ON	Source 1 available	Source 2 available
LED OFF	Source 1 not available	Source 2 not available
LED blinking	- a timer is counting down	- a timer is counting down

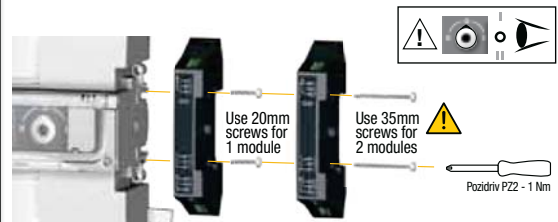

Use 20mm screws for 1 module

Use 35mm screws for 2 modules

Posidriv PZ2 - 1 Nm

4. ATYS T M VERSIONS

The ATyS t M is available as 4P with the possibility of being used on virtually any automatic open transition type of application.

Measurement accuracy: Frequency: 1 % - Voltage: 1 %

4.1. Product presentation

This quick-acting transfer switch incorporates:

1. 2 mechanically interlocked switches.
2. A quick-acting electric control unit enabling automatic or manual system operation.
3. Electrical specifications compliant with product standards, and a version identification.
4. Changeover switch wiring identification.
5. Connection of control/command circuits.



Ensure that the load is connected to the top of the switch with the motorisation on the right hand side as shown.

4.2. Specifications and advantages

1 - Power section:

A fully integrated and interlocked transfer switch, with high electrical performance offering microprocessor control and monitoring.







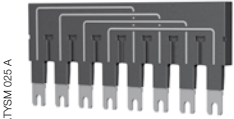

2 - Operation:

A flexible operating mechanism enabling quick motorised transfer in automatic mode or locally in manual mode for emergency operations. Features a locking device to ensure (in position zero) a secured isolation of the load (padlocked).

4.3. Supply types

The power supply of ATyS t M is required to be 230VAC \pm 30% at a frequency of 50/60 Hz and has been developed so as to meet most network configurations.

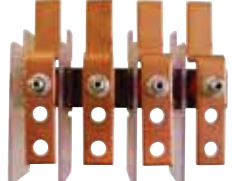
5. OPTIONAL ACCESSORIES

<p>Auxiliary contacts</p>	<p>Each product can take up to 2 auxiliary contact blocks. Each accessory integrates 1 NOC auxiliary contact (for each position I, O and II) 1309 0001 or NONC for 1309 0011.</p> <p>Characteristics: 250 VAC / 5 A maximum.</p>		<p>Ref. : 1309 0001 Ref. : 1309 0011</p>
<p>Bridging bars</p>	<p>To provide a common point on the outgoing side of the switch (load side).</p>		<p>2 Refs are available: Rating \leq 125A: 1309 4006 and rating 160A: 1309 4016</p>
<p>Voltage sensing and power supply tap</p>	<p>It allows connection of 2 x 1.5 mm² voltage sensing or power cables. The single-pole voltage sensing tap can be mounted in the terminals without reducing their connecting capacity. Do not use with the bridging bar.</p>		<p>Ref. : 1399 4006 2 parts/ref.</p>
<p>Terminal shrouds</p>	<p>Protection against direct contacts with terminals or connecting parts. Other features: Perforations allowing remote thermographic inspection without removal. Possibility of sealing. Not for use on terminals with bridging bars fitted.</p>		<p>Ref. : 2294 4016 2 parts/ref.</p>
<p>Enclosure</p>	<p>Fully dedicated to ATyS M use, this polycarbonate enclosure provides easy access to a compact, enclosed transfer switch.</p>		<p>Ref. : 1309 9006</p>
<p>Extension unit</p>	<p>Combined with the polycarbonate enclosure, the extension box creates extra space for routing cables with a larger diameter.</p>		<p>Ref. : 1309 9007</p>
<p>Sealable cover.</p>	<p>It prevents access to the configuration panel of the ATyS t M.</p>		<p>Three phases product: Ref. : 1359 0000</p>
<p>Power connection terminals</p>	<p>The power connection terminals allow conversion of the cage terminals into bolt-on type connection terminals, enabling connection of up to two 35mm² cables or one 70mm² cable. Each power connection terminal is provided with separation screens.</p>		<p>Ref. : 1399 4017 For complete conversion, order 3 times the reference.</p>
<p>Auto-transformer</p>	<p>For use with ATyS M in 400 VAC three-phase applications without a distributed neutral. As the ATyS M has integrated measurement and power supply circuits, a neutral connection is required for 400 VAC three-phase applications. When no neutral connection is available this autotransformer (400/230 VAC, 400 VA) provides the 230 VAC required for the ATyS M to function.</p>		<p>Ref. : 1599 4121</p>
<p>Double power supply - DPS</p>	<p>Allows an ATyS t M to be supplied by two 230 Vac 50/60 Hz networks.</p>		<p>Réf. : 1599 4001</p>

6. TECHNICAL DATA

Ratings		40A	63 A	80 A	100 A	125 A	160 A
Frequencies		50/60 Hz	50/60 Hz	50/60 Hz	50/60 Hz	50/60 Hz	50/60 Hz
Thermal current I _{th} at 40 °C (A)		40	63	80	100	125	160
Thermal current I _{th} at 50 °C (A)		40	63	80	100	110*	125
Thermal current I _{th} at 60 °C (A)		40	50	63	80	100*	125
Thermal current I _{th} at 70 °C (A)		40	40	50	63	80*	100
Rated assigned insulation voltage U _i (V) (Power circuit)		600	600	600	600	600	600
Rated impulse withstand voltage U _{imp} (kV) (power circuit)		6	6	6	6	6	6
Rated insulation voltage U _i (V) (control circuit)		300	300	300	300	300	300
Rated impulse withstand voltage U _{imp} (kV) (control circuit)		2.5	2.5	2.5	2.5	2.5	2.5
Rated operational currents (A) IEC 60947-3 at 415VAC at 40 °C	AC 21A / 21 B	40/40	63/63	80/80	100/100	125/125	160/160
	AC 22A / 22 B	40/40	63/63	80/80	100/100	125/125	125/160
	AC 23A / 23 B	40/40	63/63	80/80	100/100	125/125	125/160
Rated operational currents (A) IEC 60947-6-1 415Vac at 40 °C	AC 33B / AC32B **AC 33iB	40/40	63/63	80/80	100/100	125/125	125**/160
Fuse protected short-circuit withstand if using gG DIN fuses	Fuse protected short-circuit withstand (kA eff)	50	50	50	50	50	40
	Associated fuses (gG DIN)	40	63	80	100	125	160
Short-circuit capacity	Rated short-term withstand current: I _{cw} 1s (kA eff)	4	4	4	4	4	4
	Rated short-term withstand current: I _{cw} 30ms (kA eff)	10	10	10	10	10	10
Switching time at I _n excluding loss of supply sensing time and excluding any delay timers applicable.	I-II or II-I (ms)	180	180	180	180	180	180
	Duration of "electrical blackout" at U _n (ms)	90	90	90	90	90	90
	I-O / O-I / II-O / O-II (ms)	45	45	45	45	45	45
Consumption	Inrush current(A)	20	20	20	20	20	20
	Consumption in stabilised state (VA)	6	6	6	6	6	6
Mechanical characteristics	Number of changeovers	10000	10000	10000	10000	10000	10000
Connection cross-section (⚠ not compatible with aluminium cables)	Minimum size (Cu mm ²), flexible and rigid	10	10	10	10	10	10
	Maximum size (Cu mm ²), flexible and rigid	70	70	70	70	70	70
Equipment class (According to IEC 60947-6-1)		PC	PC	PC	PC	PC	PC
EMC environment		A	A	A	A	A	A

* Possibility of reaching 125A with bigger connection cross-sections and use of the 160A bridging bar.

** AC 33iB 160A according to GB 14048.11.



This is a class A product. In a domestic environment, this product may cause radio interference in which case the user may be required to take adequate measures.

7. ENVIRONMENTAL CONDITIONS



Humidity

- 80 % humidity without condensation at 55 °C
- 95 % humidity without condensation at 40 °C



Temperature

- -20 +40 °C without de-rating
- 40 °C < t ≤ 70 °C with de-rating (see Technical Characteristics)



Altitude

- Max 2000 m without de-rating

Correction factors:

	2 000 m < A ≤ 3 000 m	3 000 m < A ≤ 4 000 m
UE	0.95	0.80
le	0.85	0.85



Storage

- 1 year maximum
- Maximum storage temperature: +55 °C
- 80 % humidity without condensation at 55 °C



IP rating

- IP41 in the SOCOMEC polycarbonate modular enclosure see page 20
- IP2x for non-enclosed modular product

Protection class: Class 1

8. PRODUCT INSTALLATION



Prior to installation of the product ensure that the padlocking setting screw (located at the back of the product) is configured as per your requirements.
For locking in Positions I, II and 0, refer to the following procedure

8.1. Changing the padlocking configuration

To configure the locking in the 3 positions:

STEP1: loosen the screw at the back of the product as shown below.

STEP2: slide the screw upwards.

STEP3: tighten the screw in the top position as shown.

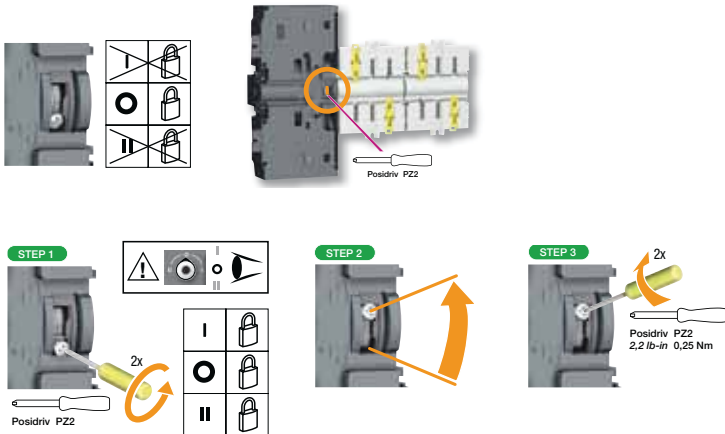

8.2. Recommended orientation

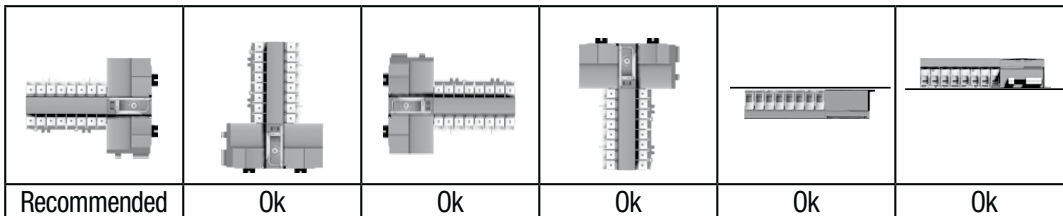

8.3. Dimensions

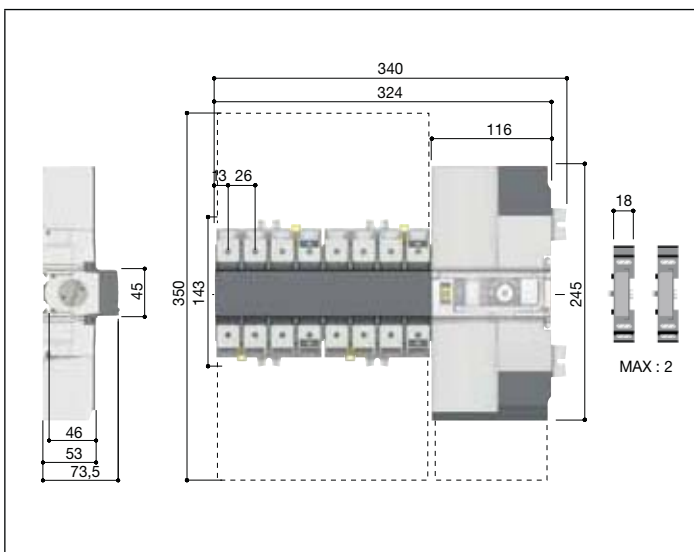

8.4. Back plate mounted

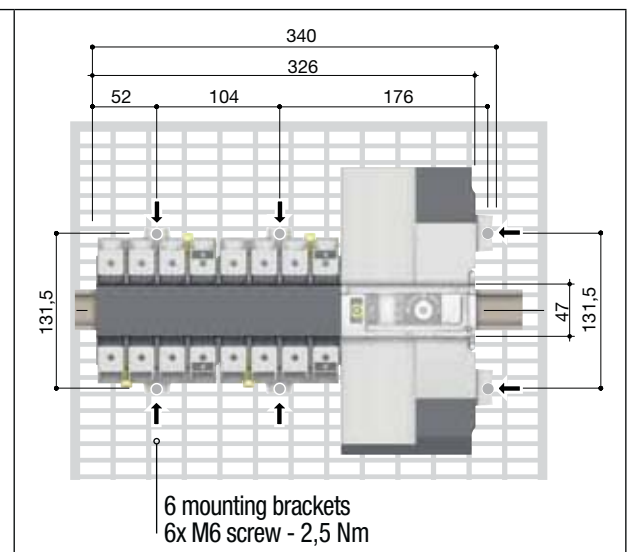

8.5. DIN rail mounted

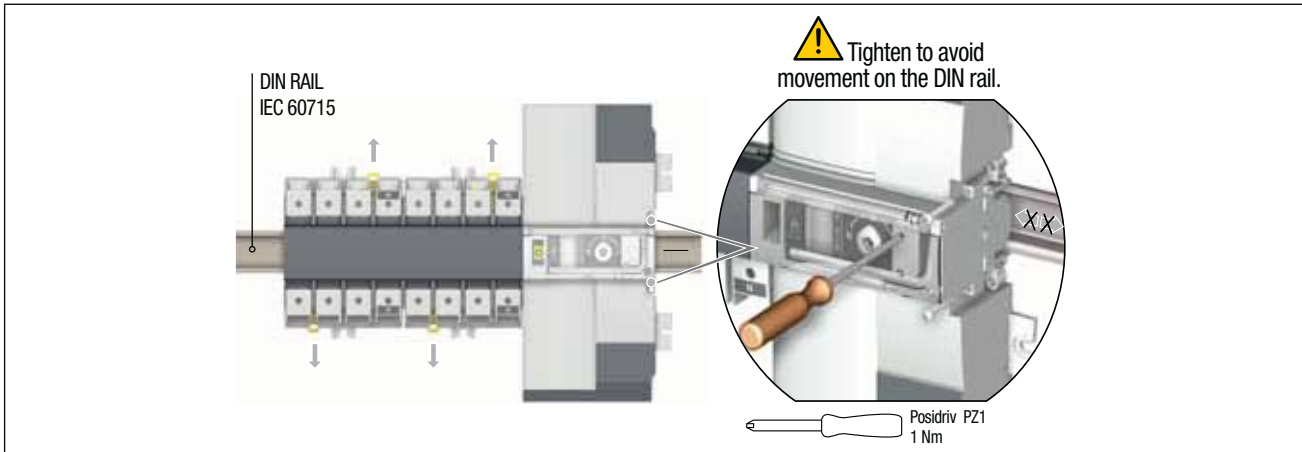

9. INSTALLATION OF OPTIONAL ACCESSORIES

9.1. Auxilliary contacts

Ref. 1309 0001 or ref. 1309 0011.

To fit an AC, the switch must first be put in the 0 position. An auxiliary contact module comprises: one NO/NC changeover contact for each position (I-0-II). To install use the screws supplied with the module.

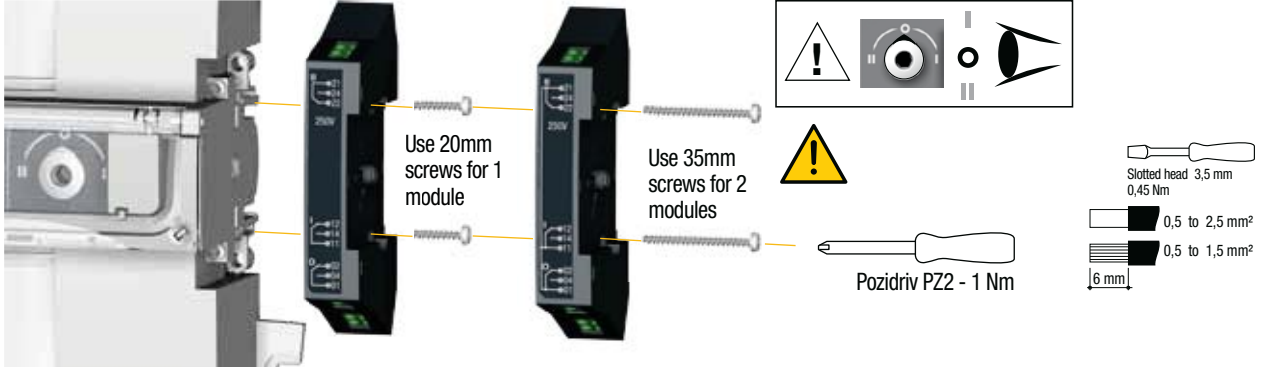

9.2. Voltage sensing and power supply tap

Ref. 1399 4006.

This provides 2 connection terminals for conductors with cross-section $\leq 1.5 \text{ mm}^2$.

The single pole terminals can be fitted in any of the terminal cages without reducing the cage connection capacity. 2 parts/ref. Do not use in case of use of the bridging bar.

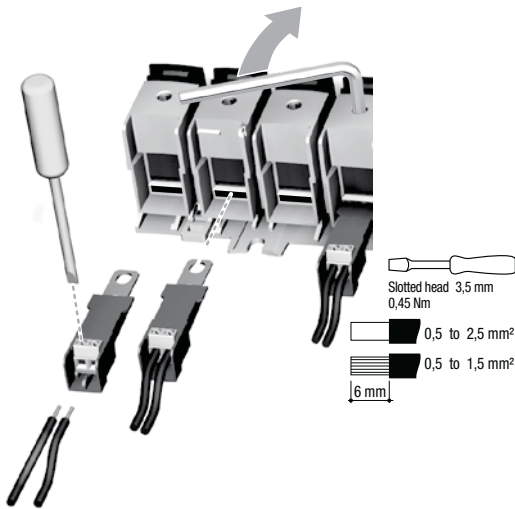

9.3. Bridging bars 4P

Ratings $\leq 125\text{A}$: ref. 1309 4006; 160A: ref. 1309 4016

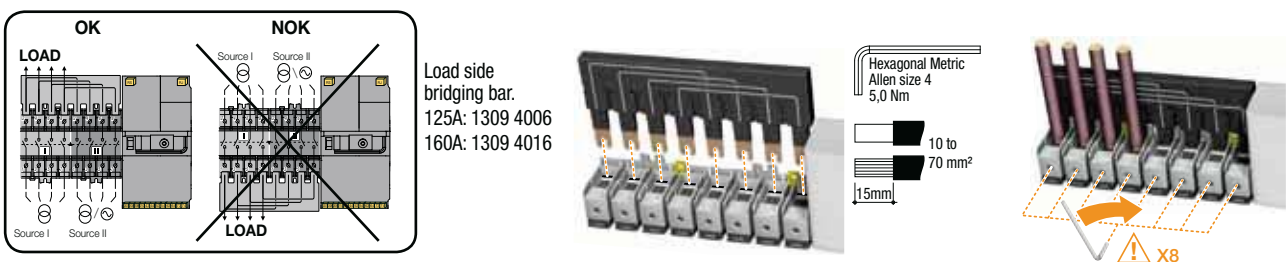

Make sure that the bridging bar is fitted to the correct set of terminals. There are two references available: one for ratings up to 125A, and another for 160A rating.

9.4. Terminal shrouds

Ref. 2294 4016

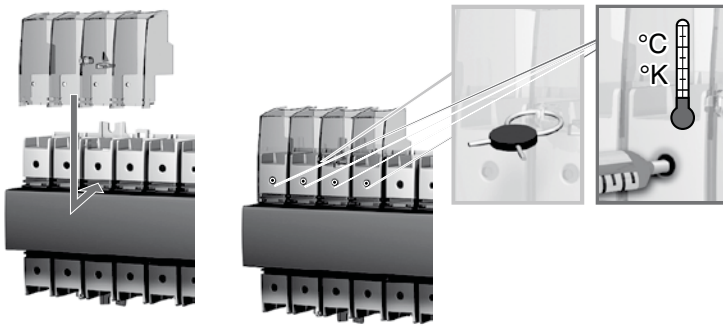

9.5. Sealable cover

Ref. 1359 0000



10. INSTALLING WITHIN THE ATYS M ENCLOSURE

10.1. Polycarbonate enclosure

Ref. 1309 9006

Dimensions and mounting

The enclosure must be wall-mounted using screws (not supplied). Recommended size: M6 50 mm (minimum).
Weight: between 8 and 10 kg, depending on the accessories.



Only 1 aux contact block may be installed when using this enclosure.

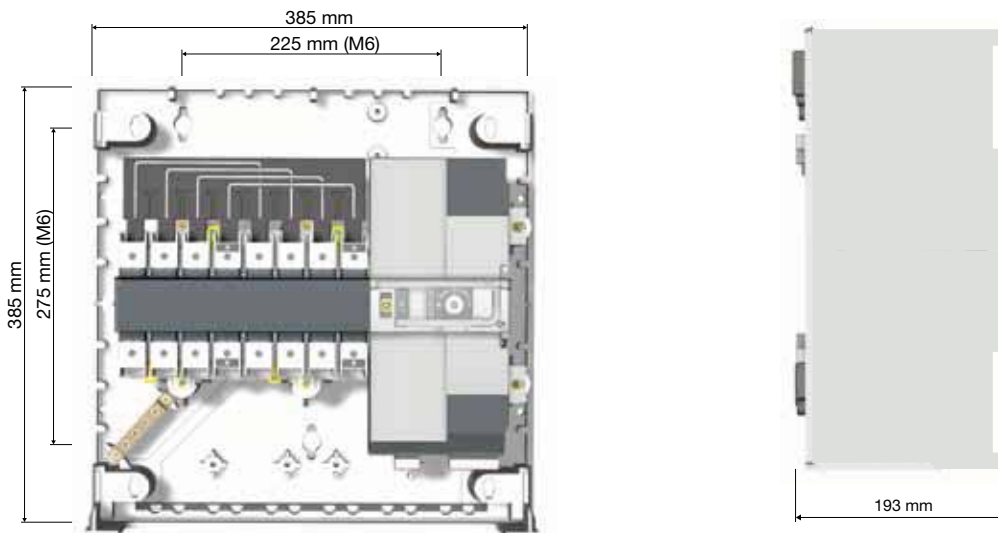

10.1.1. Wiring in a polycarbonate enclosure

Example: Neutral on the right



Max cable size 25 mm²

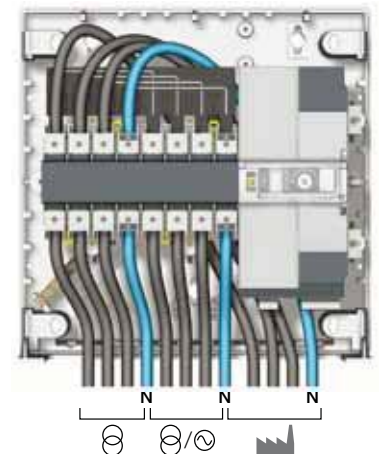

10.1.2. Extension unit

Ref. 1309 9007

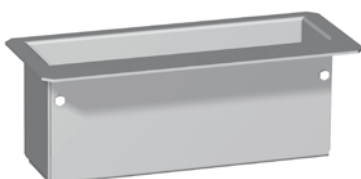

Enables you to allocate additional space to the polycarbonate enclosure (ref. 1309 9006).

11. CONNECTION OF THE POWER CIRCUITS

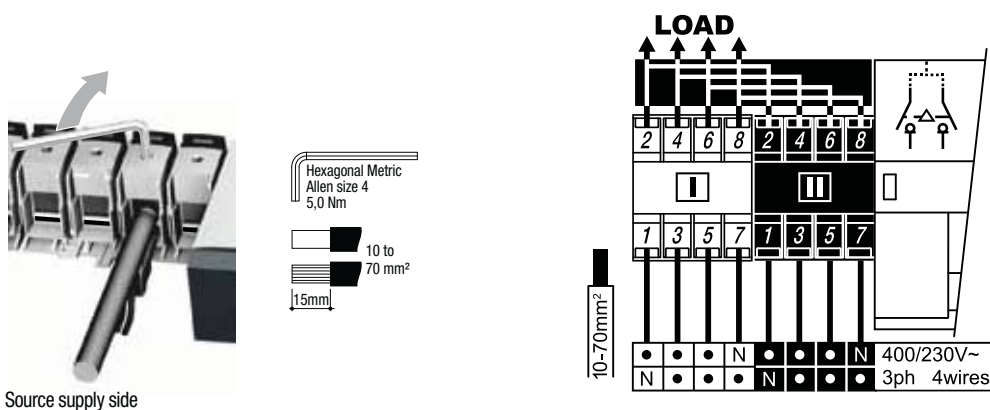

 It is essential to tighten all terminals (even those that are not used).

11.1. Ratings / cross-sections table of correspondence

	40 A	63 A	80 A	100 A	125 A	160 A
Min cable size recommended (mm ²)	10	16	25	35	50	50
**Max cable size recommended (mm ²)	50	50	50	50	70*	70*

*With extension unit.

** Maximum cable size for rigid cable is 50 mm². For larger terminations use the power connection terminals ref. 1399 4017.

 Not compatible with aluminium cables

11.2. Parallel pole set-up for a 4P device used in single phase

Rating conversion table for use in single phase and two-by-two parallel pole set up.
(Max ambient temperature = 40 °C).

Nominal current rating in three-phase (A)	Nominal current rating in single-phase (2 poles in //) (A)
40	63
63	100
80	125
100	160
125	200
160	250

11.3. Network configurations

Configuration of the network is done through the ATyS t M autoconfiguration feature. Refer to section «13.4. Programming», page 28.

11.3.1. Three phase without neutral network

For three-phase networks without neutral (3NBL) 400Vac, a neutral must be recreated to allow the ATyS t M to operate at 230Vac. To recreate the neutral, we recommend the use of quantity 2x 400VA auto-transformers connected as shown below. The neutral position must be defined as neutral on the left or neutral on the right in advance and then wired accordingly. The example below shows the wiring for a product configured with neutral on the left



A new product must have the neutral configuration pre-programmed as on the left or on the right at the first start up using a real (not a recreated) 3 phase + neutral supply.

11.3.1.1. Auto-transformer connections

Reference 1599 4121

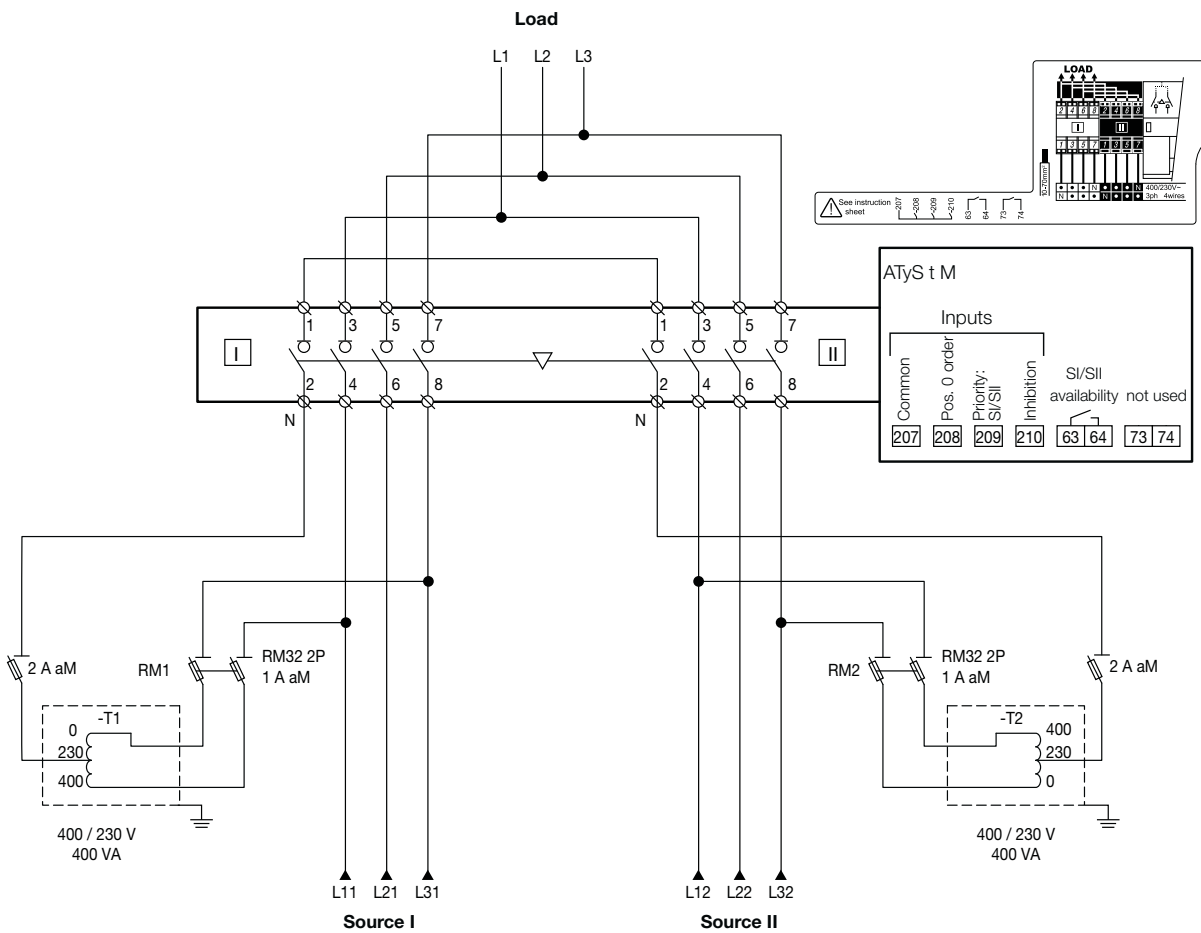

Note : phase unbalanced is not active in 3NBL configurations.

12. CONNECTION OF CONTROL/COMMAND CIRCUITS



Switch to manual mode before connecting the product. (Front Auto/Manu cover open). The product is delivered in the 0 position.

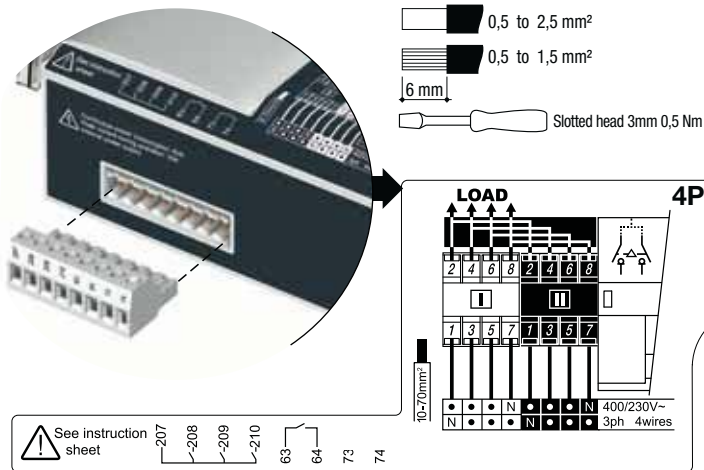
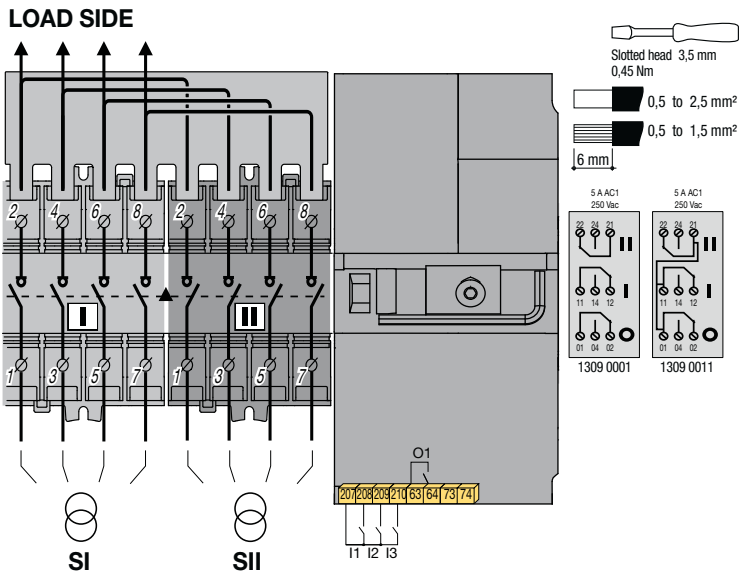

All pressure on the connector pins is to be avoided during wiring of the auxiliary cables



The product is delivered in the 0 position and in auto mode. Maximum control cables length = 10 m. In case of longer distance, use control relays.

Source must always be connected as show above.

Ensure that the product is in Manual Mode (front cover open).



12.1. Terminal connectors designation

Type	Terminal no.	Description	Characteristics	Recommended connection cross-section
Inputs	207	Common	Do not connect to any power supply	0,5 to 2,5 mm ² (rigid) 0,5 to 1,5mm ² (stranded)
	208*	Position 0 order		
	209	Open SI priority. Closed S2 priority.		
	210	Inhibition ATS		
Outputs	63/64	Open: SI and S2 NOT available. Closed: SI or S2 available		
	73/74	Not used		

Note:

* When input 207 / 208 is closed, the product switches immediately to the position zero (electrical security). Moreover, the product goes into fault mode, and all the automatism is stopped. This function is possible only if the opposite source is available:

- position 1 / source 2 available,
- position 2 / source 1 available.

To restart the automatism you need to open the contact and to have an action to erase the fault (manual mode, inhibition mode, priority change).

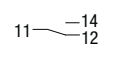
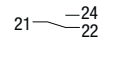
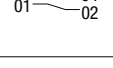
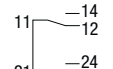
Type	Terminal no.	Status of the contact	Description	Output characteristics	Recommended connection cross-section
Auxiliary contact block 1309 0001	11/12/14		Changeover switch in position I	250V AC 5A AC1 30 Vdc 5 A	0.5 to 2.5 mm ² (rigid) 0.5 to 1.5 mm ² (stranded)
	21/22/24		Changeover switch in position II	250V AC 5A AC1 30 Vdc 5 A	
	01/02/04		Changeover switch in position 0	250V AC 5A AC1 30 Vdc 5 A	
Auxiliary contact block 1309 0011	11/12/14		Changeover switch in position I	250V AC 5A AC1 30 Vdc 5 A	
	21/22/24		Changeover switch in position II	250V AC 5A AC1 30 Vdc 5 A	
	01/02/04		Changeover switch in position 0	250V AC 5A AC1 30 Vdc 5 A	

12.2. Auxiliary contact operating schedule

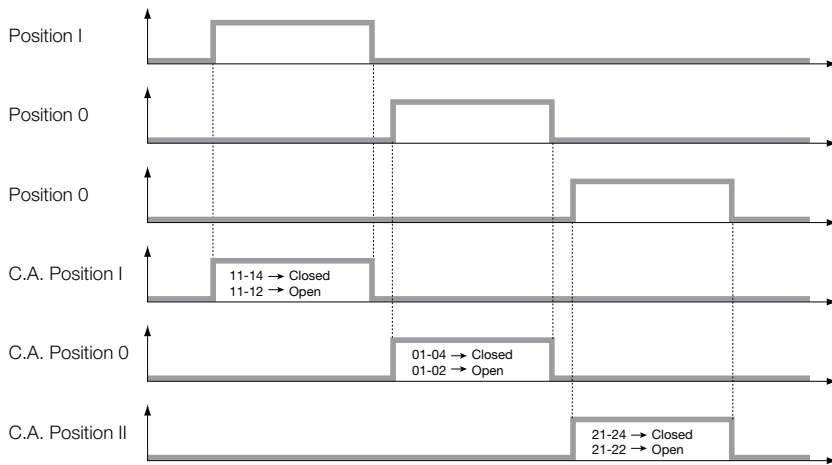

13. OPERATION

13.1. Presentation of the product interface

13.1.1. Product interface

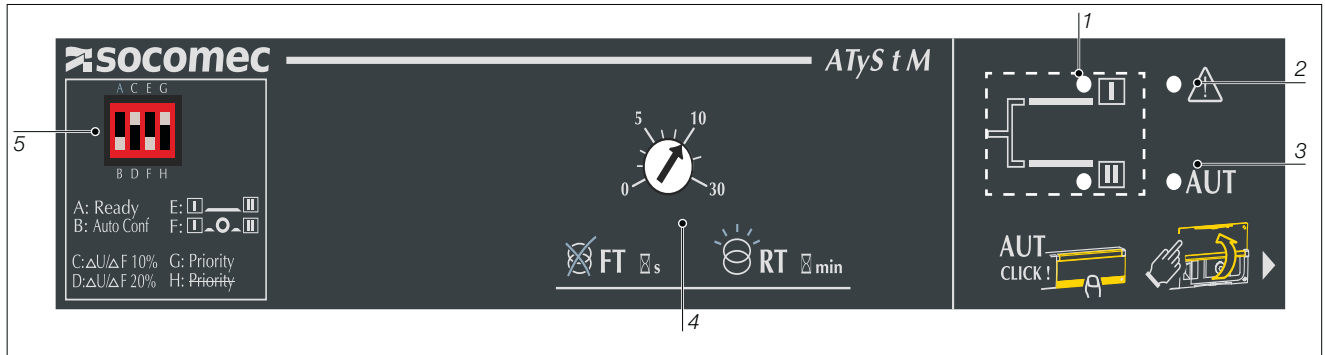

- 1. Source I and Source II availability indicators
- 2. Fault LED
- 3. Auto LED
- 4. Potentiometers to set timers
- 5. Dip switches

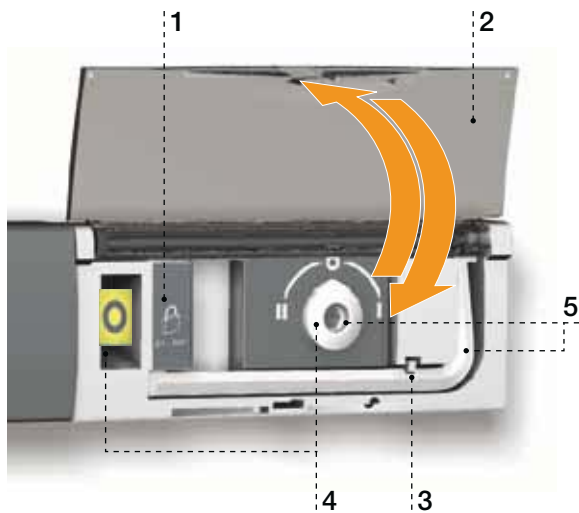

1. Locking

- Option to padlock using a 1 x 8 mm max. padlock.

2. AUT/MAN cover

- Open the cover to switch to manual mode.
- Close the cover to return to automatic (remote control) mode.
- Open and close the cover to clear faults.

3. Auto/Manual mode sensor

4. Switch position indicators

- Display of position I, 0, II.

5. Manual switching

- Insert the Allen key (5.0 mm) provided and turn to switch manually.
- Manual operation is not possible when padlocked.

13.1.2. Reset

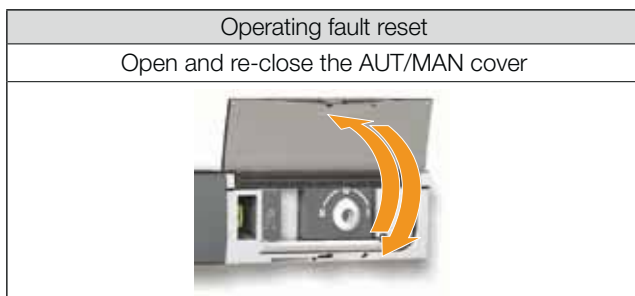

13.2. Manual mode

To access manual mode, open the Aut/Man cover.

Once manual mode is active (cover open) it is possible:

- To lock the changeover switch.
- To access the DIP switches programming.
- To manually operate the changeover switch using the handle.

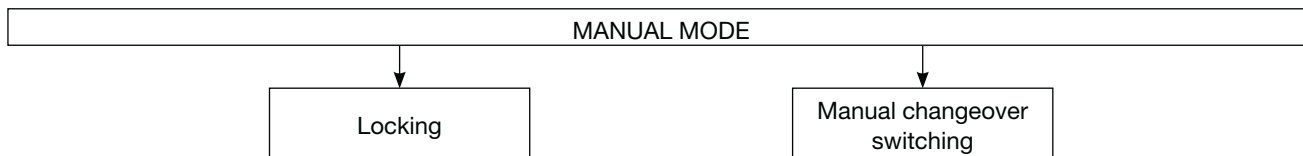

13.2.1. Manual switching

Use the handle situated on the front panel under the cover to manoeuvre the changeover switch. To simplify the operation, it is advised to also use the handle extension that is delivered with the product.

Check the changeover switch position on the indicator situated on the front panel before making any operation.

- From position I, turn anti-clockwise to get to position 0
- From position 0, turn anti-clockwise to get to position II
- From position II, turn clockwise to get to position 0
- From position 0, turn clockwise to get to position I



Do not force the product (Max 8 Nm).

13.3. Padlocking

Enables locking in the 0 position (factory configuration) or in positions I, 0 or II (user configurable).

It is necessary to configure padlocking to all positions before installation as access to configuration is at the back of the product. Refer to section «8.1. Changing the padlocking configuration», page 16

Locking is only possible in manual mode (cover open).

Pull on the locking handle to enable the interlock. Lock by inserting a padlock into the orifice provided for this purpose.



13.4. Programming

Whilst in manual mode check the wiring and installation. If ok power up the product.
 This product must always be put into service by qualified and approved personal.
 The LED signalling is only active when the product supply is on (supply LED lit).
 To set the dip switches, it is necessary to open the AUTO/MANU cover.

**The commissioning must always result in having at least 1 LED source available lit..
 Therefore, the voltage and frequency must be within the defined thresholds.**



Any action on the potentiometers changes the settings, even if the cover is closed.

13.4.1. Auto-configuration

Once the product is connected, you can configure automatically its nominal voltage & nominal frequency.
 Therefore, while front cover is open:
 1. Put dip switch A-B in position B.
 2. All leds are blinking.
 3. All leds are on, not blinking anymore.
 4. Put dip switch A-B in position A: product is ready to work.

The LED signalling and operation is only active when the product supply is available.
 To set the dip switches, it is necessary to open the Auto/Manual cover.
 Commissioning must always result in having at least 1 LED source available on.
 (Therefore, the voltage and frequency must be within the defined thresholds).

Any action on the potentiometers will change the settings, even when the cover is closed.

A Dip switch settings

Setting mode: A-B

- A: Ready
- B: Auto Conf (Auto-configuration)

Thresholds: C-D

- C: ΔU 10%/ ΔF 5%
- D: ΔU 20%/ ΔF 10%

Stop in 0 position: E-F

- E: No stop in 0 position
- F: 2s stop in 0 position

Type of application: G-H

- G: With priority
- H: Without priority

B Timer settings

Loss of priority source timer

FT: 0-30 sec.

Return of priority source timer

RT: 0-30 min.

C Led info

Source availability LED

Source	LED ON	LED OFF	LED blinking
	Source 1 available	Source 1 missing or out of range	- a timer is counting down - test mode
	Source 2 available	Source 2 missing or out of range	- a timer is counting down

Fault and state of the product Leds

	LED ON	LED OFF	LED blinking
	Fault	Product OK	Wait
AUT	Auto mode	Manual mode	Manual retransfer

Fault reset

A C E G
B D F H

A: Ready E:

B: Auto Conf F:

C: $\Delta U/\Delta F$ 10% G: Priority

D: $\Delta U/\Delta F$ 20% H: Priority

ATyS t M

FT s RT min

AUT
CLICK!

13.4.2. Sealable configuration cover

Configuration settings may be protected by means of a sealable cover. Refer to section «5. Optional accessories», page 13.



13.5. Automatic mode

Close the cover to enter automatic mode. Make sure that the changeover switch is in automatic mode (AUT LED lit).

13.5.1. Sealable Auto/Manual cover

Auto/Manu mode can be protected by sealing the standard Auto/Manu cover as shown.

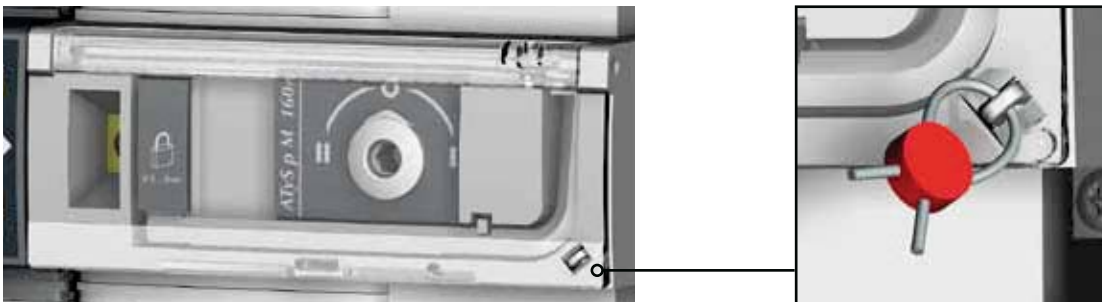

13.6. Possible actions

Once in automatic mode, it is possible to:

- Run a source I / source loss sequence II,
- start a restoration sequence source I / source II.

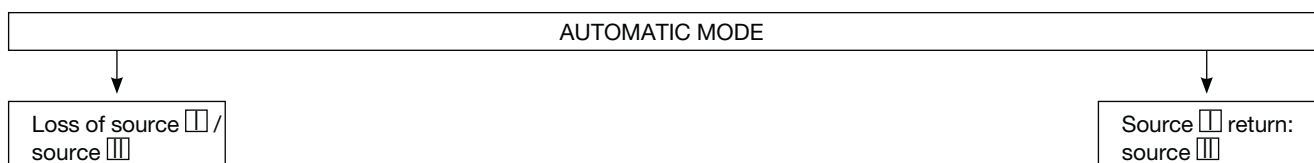

14. PREVENTATIVE MAINTENANCE

It is recommended to operate the product at least once a year.

I - O - II - O - I

Note: Maintenance should be planned carefully and carried out by qualified and authorised personnel. Consideration of the critical level and application where the product is installed should form an essential and integral part of the maintenance plan. Good engineering practice is imperative whilst all necessary precautions must be taken to ensure that the intervention (whether directly or indirectly) remains safe in all aspects.



The use of any Megohmmeter is prohibited on this product as the connection terminals are intrinsically connected to the sensing circuit.

15. TROUBLESHOOTING GUIDE

Problem	Actions	Expected results
Product is off, i.e. no LEDs are ON.	Check for 176-288VAC across terminals 1 and 7 on switch I and II.	The AUT LED is ON with manual operation cover closed.
SOURCE1 availability LED is OFF.	<p>Voltage and frequency auto configuration:</p> <ul style="list-style-type: none"> - Step 1: open manual operation cover. - Step 2: set dip switch A-B to position B. - Step 3: when all LEDs are on, return dip switch A-B to position A - Step 4: re-close the cover. <p>Check the value of the voltage and frequency thresholds (dip switch C-D). Set to maximum level and reduce later if applicable.</p> <p>Check the following parameters:</p> <ul style="list-style-type: none"> - network type: Must be a 3 phase network + neutral (or transformer), - nominal voltage: Must be between 176 and 288 Vac, - nominal frequency: Must be between 45 and 65 Hz. 	SOURCE 1 LED is ON.
SOURCE 2 availability LED is OFF.	<p>Voltage and frequency auto configuration:</p> <ul style="list-style-type: none"> - Step 1: open manual operation cover, - Step 2: set dip switch A-B to position B, - Step 3: when all LEDs are on, return dip switch A-B to position A, - Step 4: re-close the cover. <p>Check the value of the voltage and frequency thresholds (dip switch C-D). Set to maximum level and reduce later if applicable.</p> <p>Check the following parameters:</p> <ul style="list-style-type: none"> - network type: Must be a 3 phase network + neutral (or transformer), - nominal voltage: Must be between 176 and 288 Vac, - nominal frequency: Must be between 45 and 65 Hz. 	SOURCE 2 LED is ON.

Problem	Actions	Expected results
Switch remains off after loss of Priority source; i.e. no LEDs are ON.	Check for 176-288VAC across power terminals 1 and 7 on switch II.	The AUT LED is ON with manual operation cover closed.
The switch does not transfer after loss of priority source.	Check that the product is not in manual mode: - Automatic mode = Cover closed - Manual mode = Cover open.	The AUT LED is ON.
	Check that automatic operation has not been inhibited by an external order (terminals 207-210).	
	Check that the backup source is seen as available; appropriate source availability LED is ON. If it is not ON refer to above actions for "SOURCE x availability LED is OFF". Check that automatic operation has not been inhibited by an external order (terminals 207-210).	The AUT and the backup SOURCE LEDs are ON.
	Check FT (Main Failure Timer) configuration, which can be configured between 0 and 30s. The changeover will only take place at the end of FT.	When FT reaches zero the switch will operate to position 0 before finally transferring to its backup position.
The switch does not return to its priority position after the priority source has been restored.	Check that the product is not in manual mode: - Automatic mode = Cover closed, - Manual mode = Cover open.	The AUT LED is ON.
	Check that automatic operation has not been inhibited by an external order (terminals 207-210).	
	Check that the priority source is seen as available; appropriate source availability LED is ON. If it is not ON refer to above actions for "SOURCE x availability LED is OFF".	The AUT and the priority SOURCE LEDs are ON.
	Check RT (Main Return Timer) configuration which can be configured between 0 and 30min. The changeover will only take place at the end of MRT.	When RT reaches zero the switch will operate to position 0 before finally transferring to its priority position.

Socomec worldwide

IN EUROPE

BELGIUM

Critical Power / Power Control & Safety /
Energy Efficiency / Solar Power
Tel. +32 2 340 02 30
Fax +32 2 346 28 99
info.be@socomec.com

FRANCE

Critical Power / Power Control & Safety /
Energy Efficiency / Solar Power
Tel. +33 1 45 14 63 00
Fax +33 1 48 67 31 12
dcm.ups.fr@socomec.com

GERMANY

Critical Power
Tel. +49 621 71 68 40
Fax +49 621 71 68 444
info.ups.de@socomec.com
Power Control & Safety / Energy Efficiency
Tel. +49 7243 65292 0
Fax +49 7243 65292 13
info.scp.de@socomec.com

ITALY

Critical Power
Tel. +39 02 98 242 942
Fax +39 02 98 240 723
info.ups.it@socomec.com
Power Control & Safety / Energy Efficiency
Tel. +39 02 98 49 821
Fax +39 02 98 24 33 10
info.scp.it@socomec.com
Solar Power
Tel. +39 0444 598611
Fax +39 0444 598627
info.solar.it@socomec.com

NETHERLANDS

Critical Power / Power Control & Safety /
Energy Efficiency / Solar Power
Tel. +31 30 760 0900
Fax +31 30 637 2166
info.nl@socomec.com

POLAND

Critical Power / Solar Power
Tel. +48 22 825 73 60
Fax. +48 22 825 73 70
info.ups.pl@socomec.com
Power Control & Safety / Energy Efficiency
Tel. +48 91 442 64 11
Fax +48 91 442 64 19
info.scp.pl@socomec.com

PORTUGAL

Critical Power / Power Control & Safety /
Energy Efficiency / Solar Power
Tel. +351 261 812 599
Fax +351 261 812 570
info.ups.pt@socomec.com

ROMANIA

Critical Power / Power Control & Safety /
Energy Efficiency / Solar Power
Tel. +40 21 319 36 88
Fax +40 21 319 36 89
info.ro@socomec.com

RUSSIA

Critical Power / Power Control & Safety /
Energy Efficiency / Solar Power
Tel. +7 495 775 19 85
Fax +7 495 775 19 85
info.ru@socomec.com

SLOVENIA

Critical Power / Power Control & Safety /
Energy Efficiency / Solar Power
Tel. +386 1 5807 860
Fax +386 1 561 11 73
info.si@socomec.com

SPAIN

Critical Power / Power Control & Safety /
Energy Efficiency / Solar Power
Tel. +34 93 540 75 75
Fax +34 93 540 75 76
info.es@socomec.com

TURKEY

Critical Power / Power Control & Safety /
Energy Efficiency / Solar Power
Tel. +90 216 540 71 20-21-22
Fax +90 216 540 71 27
info.tr@socomec.com

UNITED KINGDOM

Critical Power
Tel. +44 1285 863 300
Fax +44 1285 862 304
info.ups.uk@socomec.com
Power Control & Safety / Energy Efficiency
Tel. +44 1462 440 033
Fax +44 1462 431 143
info.scp.uk@socomec.com

IN ASIA PACIFIC

AUSTRALIA

Critical Power / Power Control & Safety
Tel. +61 2 9325 3900
Fax +61 2 9888 9544
info.ups.au@socomec.com

CHINA

Critical Power / Power Control & Safety /
Energy Efficiency
Tel. +86 21 52 98 95 55
Fax +86 21 62 28 34 68
info.cn@socomec.com

INDIA

Critical Power / Power Control & Safety /
Energy Efficiency / Solar Power
Tel. +91 44 39215400
Fax +91 44 39215450 & 51
info.in@socomec.com

SINGAPORE

Critical Power / Power Control & Safety /
Energy Efficiency
Tel. +65 6506 7600
Fax +65 64 58 7377
info.sg@socomec.com

THAILAND

Critical Power
Tel. +66 2 941 1644 7
Fax +66 2 941 1650
info.ups.th@socomec.com

IN MIDDLE EAST

UNITED ARAB EMIRATES

Critical Power / Power Control & Safety /
Energy Efficiency / Solar Power
Tel. +971 4 29 98 441
Fax +971 4 29 98 449
info.ae@socomec.com

IN AMERICA

USA, CANADA & MEXICO

Power Control & Safety / Energy Efficiency
Tel. +1 617 245 0447
Fax +1 617 245 0437
info.us@socomec.com

OTHER COUNTRIES

NORTH AFRICA

Algeria / Morocco / Tunisia
info.naf@socomec.com

AFRICA

Other countries
info.africa@socomec.com

SOUTH EUROPE

Cyprus / Greece / Israel / Malta
info.se@socomec.com

SOUTH AMERICA

Tel. +34 93 540 75 75
info.es@socomec.com

MORE DETAILS

www.socomec.com/worldwide

HEAD OFFICE

SOCOMECS GROUP

SAS SOCOMECS capital 10 816 800€
R.C.S. Strasbourg B 548 500 149
B.P. 60010 - 1, rue de Westhouse
F-67235 Benfeld Cedex - FRANCE
Tel. +33 3 88 57 41 41
Fax +33 3 88 74 08 00
info.scp.isd@socomec.com

www.socomec.com

YOUR DISTRIBUTOR

