

INSTRUCTION
MANUAL

ATyS *d* M

Remotely Operated
Transfer Switching Equipment

EN





www.socomec.com

www.socomec.com/en/atys-d-m

To download, brochures, catalogues and technical manuals :

This manual is available for download in French, English, German, Italian, Spanish, Dutch, Portugese, Russian, Polish, Turkish and Chinese.

INDEX

1. GENERAL SAFETY INSTRUCTIONS	6
2. INTRODUCTION.....	7
2.1. THE ATYS FAMILY PRODUCT RANGE	7
2.2. THE ATYS M RANGE KEY FEATURES	8
2.2.1. SELECTION GUIDE	9
3. QUICK START	10
3.1. QUICK START ATYS D M (2P).....	10
3.2. QUICK START ATYS D M (4P).....	12
4. ATYS D M VERSIONS.....	14
4.1. PRODUCT PRESENTATION	14
4.2. SPECIFICATIONS AND ADVANTAGES	14
4.3. SUPPLY TYPES.....	14
5. OPTIONAL ACCESSORIES	15
6. TECHNICAL DATA.....	17
7. ENVIRONMENTAL CONDITIONS	18
8. PRODUCT INSTALLATION.....	19
8.1. CHANGING THE PADLOCKING CONFIGURATION	19
8.2. RECOMMENDED ORIENTATION	19
8.3. DIMENSIONS OF THE SINGLE PHASE PRODUCT	19
8.4. BACK PLATE MOUNTED SINGLE PHASE PRODUCT.....	19
8.5. DIMENSIONS OF THE THREE PHASE PRODUCT.....	20
8.6. BACK PLATE MOUNTED THREE PHASE PRODUCT	20
8.7. DIN RAIL MOUNTED	20
9. INSTALLATION OF OPTIONAL ACCESSORIES.....	21
9.1. AUXILLIARY CONTACTS	21
9.2. VOLTAGE SENSING AND POWER SUPPLY TAP	21
9.3. BRIDGING BARS 2P	21
9.4. BRIDGING BARS 4P	22
9.5. TERMINAL SHROUDS.....	22
10. INSTALLING WITHIN THE ATYS M ENCLOSURE	23
10.1. MODULAR PLASTIC ENCLOSURE	23

10.2. POLYCARBONATE ENCLOSURE	23
10.2.1. WIRING IN A POLYCARBONATE ENCLOSURE	24
10.2.2. EXTENSION UNIT	24
11. CONNECTION OF THE POWER CIRCUITS.....	25
11.1. RATINGS / CROSS-SECTIONS TABLE OF CORRESPONDENCE	25
11.2. PARALLEL POLE SET-UP FOR A 4P DEVICE USED IN SINGLE PHASE	25
12. CONNECTION OF CONTROL/COMMAND CIRCUITS.....	26
12.1. TERMINAL CONNECTORS DESIGNATION	27
12.2. AUXILIARY CONTACT OPERATING SCHEDULE	27
13. OPERATION.....	28
13.1. PRESENTATION OF THE PRODUCT INTERFACE	28
13.1.1. RESET.....	28
13.2. MANUAL MODE	28
13.2.1. MANUAL SWITCHING.....	29
13.3. PADLOCKING	29
13.4. COMMISSIONING / PUTTING INTO SERVICE	29
13.5. AUTOMATIC (REMOTE) MODE.....	29
13.5.1. SEALABLE AUTO/MANUAL COVER.....	29
13.6. POSSIBLE ACTIONS.....	30
13.6.1. CONTROL LOGIC.....	30
13.6.2. POSITIONS THAT CAN BE REACHED DEPENDING ON THE AVAILABLE SOURCE	31
14. PREVENTATIVE MAINTENANCE	32
15. TROUBLESHOOTING GUIDE	33
15.1. FAULT FINDING	33
15.2. TROUBLESHOOTING	33

This page intentionally left blank

1. GENERAL SAFETY INSTRUCTIONS

- This manual provides instructions on safety, connections and operation of the ATyS M transfer switch manufactured by SOCOMEC.
- Whether the ATyS is sold as a loose product, as a spare, as an enclosed solution or as any other configuration, this device must always be installed and commissioned by qualified and experienced personnel, in line with the manufacturers recommendations, following good engineering practices and after having read and understood the details in the latest release of the relative product instruction manual.
- Maintenance on the product and any other associated equipment including but not limited to servicing operations must be performed by adequately trained and qualified personnel.
- Each product is shipped with a label or other form of marking including rating and other important specific product information. One must also refer to and respect markings on the product prior to installation and commissioning for values and limits specific to that product.
- Using the product outside the intended scope, outside SOCOMEC recommendations or outside the specified ratings and limits can cause personal injury and/or damage to equipment.
- This instruction manual must be made accessible so as to be easily available to anyone who may need to read it in relation with the ATyS.
- The ATyS meets the European Directives governing this type of product and includes CE marking on each product.
- No covers other than that for auto/manu on the ATyS should be opened (with or without voltage) as there may still be dangerous voltages inside the product such as those from external circuits.
- **Do not handle any control or power cables connected to the ATyS when voltage may be present on the product directly through the mains or indirectly through external circuits.**
- Voltages associated with this product may cause injury, electric shock, burns or death. Prior to carry out any maintenance or other work on live parts or other parts in the vicinity of exposed live parts, ensure that the switch including all control and associated circuits are de-energized.

		
DANGER	WARNING	CAUTION
RISK: Electric shock, burns, death	RISK: Possible personal injury	RISK: Equipment damage

- As a minimum the ATyS M comply with the following international standards:
 - IEC 60947-6-1
 - GB 14048-11
 - EN 60947-6-1
 - VDE 0660-107
 - BS EN 60947-6-1
 - NBN EN 60947-6-1
 - IEC 60947-3
 - IS 13947-3
 - EN 60947-3
 - NBN EN 60947-3
 - BS EN 60947-3

The information provided in this instruction manual is subject to change without notice, remains for general information only and is non-contractual.

2. INTRODUCTION

ATyS d M “Remotely Operated Transfer Switching Equipment” is designed for use in power systems for the safe transfer of a load supply between a normal and an alternate source. The changeover is done in open transition and with minimum supply interruption during transfer ensuring full compliance with IEC 60947-6-1, GB 14048-11 and other international TSE standards as listed.

The ATyS d M is a full load break (switch type) derived transfer switching equipment where the main components are proven technology devices also fulfilling requirements in IEC 60947-3 standards.



As a Class PC RTSE, the ATyS d M is capable of “making and withstanding short circuit currents” assigned to IEC 60947-3 utilization categories of up to AC23A, GB 14048-11, IEC 60947-6-1 and equivalent standards with utilization categories of up to AC33B.

ATyS d M transfer switches ensure:

- Power Control and Safety between a normal and an alternate source.
- A complete product delivered as a fully assembled and tested solution.
- Intuitive HMI for emergency / local operation.
- Integrated and robust switch disconnection.
- Window with clearly visible position indication I – 0 - II.
- An inherent failsafe mechanical interlock.
- Stable positions (I – 0 – II) non affected by typical vibration and shocks.
- Constant pressure on the contacts non affected by network voltage.
- Energy Efficient with virtually no consumption whilst on the normal, alternate or off positions.
- Extremely rugged, error free and built in padlocking facility (configurable).
- Straight forward installation with effective ergonomics.
- Auxiliary contacts for switch positions I – 0 - II (included as standard).
- Ample accessories to suit specific requirements.

2.1. The ATyS family product range

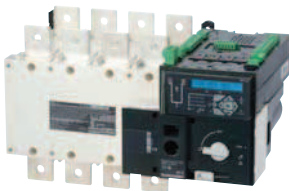
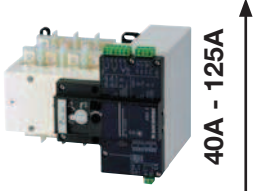
Just the right ATyS for your application...

ATyS: Small Footprint	ATyS M: Modular Profile
<p>Back to Back Configuration</p>  <p>125A - 3200A ↑</p>  <p>40A - 125A ↑</p> <p>ATyS p Power/Genset Management</p> <p>ATyS g Simple Genset Management</p> <p>ATyS t Transformer Management</p> <p>ATyS d S Small Genset with DPS</p> <p>ATyS d RTSE (DPS)</p> <p>ATyS S (RTSE) Small Genset</p> <p>ATyS r ⁽¹⁾ATyS  RTSE RTSE</p>	 <p>40A - 160A ↑</p> <p>ATyS p M Evolved Genset Management</p> <p>ATyS g M Simple Genset Management</p> <p>ATyS t M Transformer (building) Management</p> <p>ATyS d M RTSE (DPS)</p> <p>Side by Side Configuration</p>

⁽¹⁾ The UL version of ATyS r is available from 100 - 400A

2.2. The ATyS M Range Key Features

Selecting the right ATyS M will depend on the application, the functionality required as well as the nature of the installation in which the ATyS M will be installed. Below is an outline product selection chart listing the key features of each product to help you select the right ATyS M for your needs.

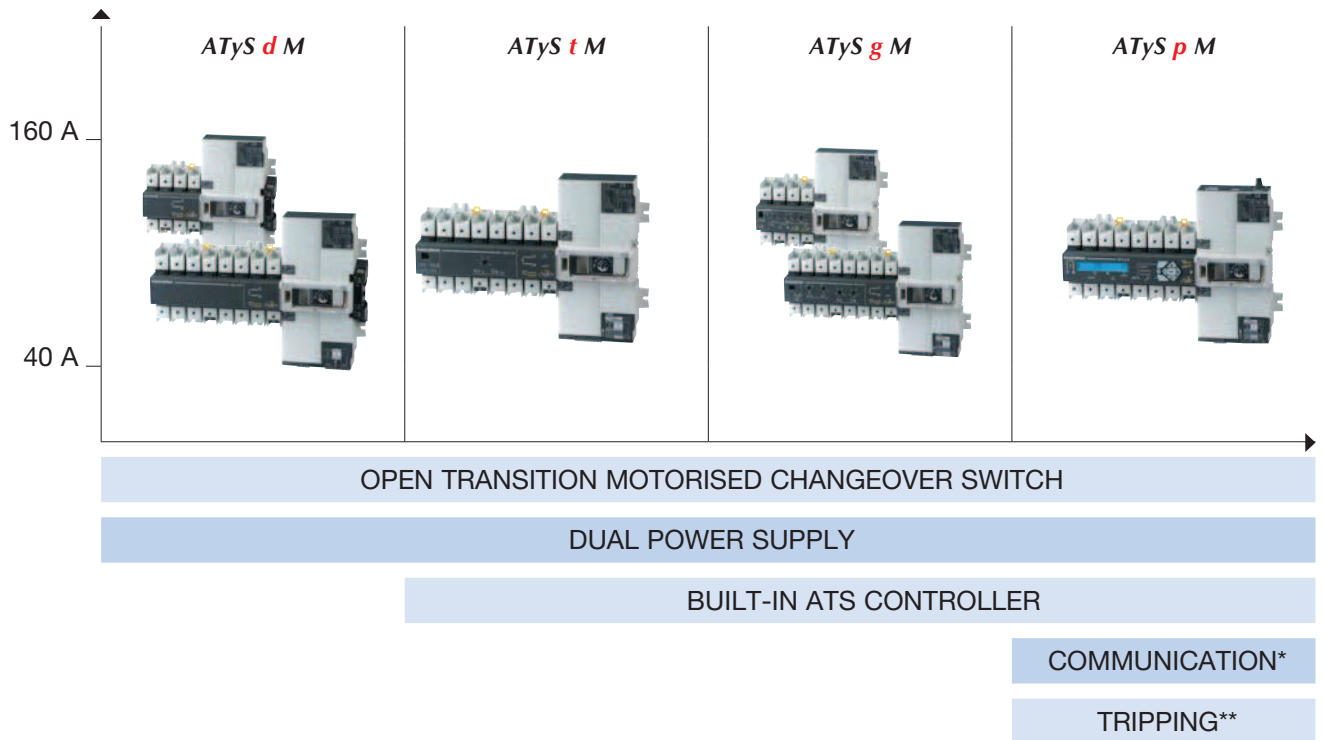

* Specific version. ** Return to zero without external energy source.

A product for virtually all power changeover applications from 40 to 160 A

- > Network/Genset
 - > Genset/Genset
 - > Network/Network
- Applications with an External ATS Control

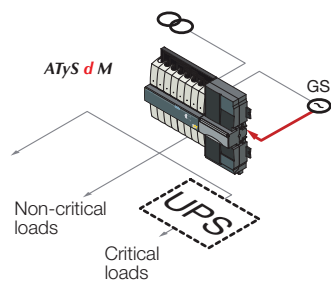

- > Network/Network
- Building applications

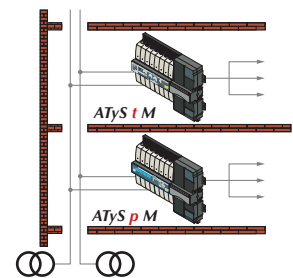

- > Network/Genset
- Genset Applications for Standby Power

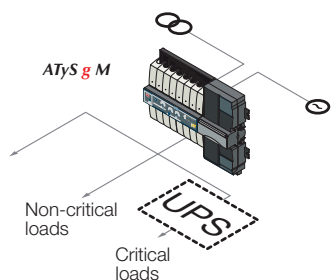

- > Network/Genset
- > Network/Network

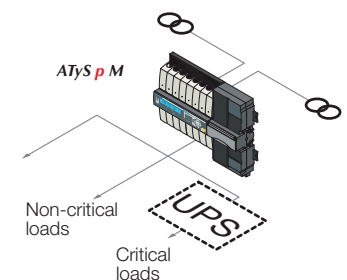

2.2.1. Selection guide

Six ratings 40/63/80/100/125/160 A

	ATyS <i>d</i> M	ATyS <i>t</i> M	ATyS <i>g</i> M	ATyS <i>p</i> M
APPLICATIONS				
Normal/Backup without automatic controller	•			
Normal/Backup with built-in automatic controller		•	•	•
Stable positions	•	•	•	•
Load changeover	•			
FUNCTIONS				
POWER SUPPLY				
External	•			
Integrated		•	•	•
OPERATION				
Backup manual operation of the 3 positions	•	•	•	•
Electrical (dry contact) control of positions I, 0 and II	•			•*
Automatic control of positions I, 0 and II		•	•	•
Return to 0 position feature upon loss of source				•
MONITORING				
3 voltages on networks I and II		•	•	•
Frequency on networks I and II		•	•	•
Phase rotation on networks I and II				•
Asymmetry of networks I and II				•
AUTOMATIC CONTROLLER CONFIGURATION				
By potentiometer and micro-switch		•	•	
By screen + keyboard				•
V _n , F _n , V threshold, F threshold		•	•	•
Driving with or without priority		•	•	•
Adjustable operating timers		•	•	•
Control type (impulse or switch/contactor)	•			
DISPLAY				
Position, fully visualised breaking	•	•	•	•
LED: source status, automatic mode, fault LED		•	•	•
LED: switch positions, supply, tests, control				•
V, F, timers, number of operations, last event				•
REMOTE CONTROL				
Outputs				
Generator start/stop order			•	•
Product availability (not fault and not manual mode)			•	•*
Source available		•		•*
Programmable output (source, availability, fault)				•*
Inputs				
Test on load			•	•*
Retransfer			•	•*
Automatic mode inhibit		•	•	•*
Position 0 order		•		•*
Priority		•	•	•
Other programmable inputs (test off-load, position control, etc.)				•*
Remote control				
Human/Machine Interface (<i>D10</i> and <i>D20</i>)				•
RS485 communication (MODBUS)				•**

* 3 inputs/3 outputs (programmable).

** Product reference is different: communication by RS485 connection (MODBUS) allows up to 31 ATyS M to be connected to a PC or a PLC over 1500 m.

3. QUICK START

3.1. Quick Start ATyS d M (2P)



QUICK START EN 40 - 160A (2P)

ATyS d M

Remotely operated
Transfer Switching Equipment

Preliminary operations

Check the following upon delivery and after removal of the packaging:

- Packaging and contents are in good condition.
- The product reference corresponds to the order.
- Contents should include:
 - Qty 1 x ATyS M
 - Qty 1 x Emergency handle extension rod
 - Qty 1 x Set of terminals
 - Quick Start instruction sheet

Warning

⚠ Risk of electrocution, burns or injury to persons and / or damage to equipment.

This Quick Start is intended for personnel trained in the installation and commissioning of this product. For further details refer to the product instruction manual available on the SOCOMEC website.

- This product must always be installed and commissioned by qualified and approved personnel.
- Maintenance and servicing operations should be performed by trained and authorised personnel.
- Do not handle any control or power cables connected to the product when voltage may be, or may become present on the product, directly through the mains or indirectly through external circuits.
- Always use an appropriate voltage detection device to confirm the absence of voltage.
- Ensure that no metal objects are allowed to fall in the cabinet (risk of electrical arcing).

Failure to observe good engineering practises as well as to follow these safety instructions may expose the user and others to serious injury or death.

⚠ Risk of damaging the device

- In case the product is dropped or damaged in any way it is recommended to replace the complete product.

Accessories

- Bridging bars and 125A or 160A.
- Voltage sensing and power supply TAP.
- Terminal shrouds.
- Additional aux contact block.
- Plastic enclosure.
- Dual Power Supply (DPS).
- Power Connection Terminals.
- ATS Control relay ATyS C30 + D10 or D20.
- ATS control relay ATyS C20.
- ATS control relay ATyS C40.



www.socomec.com
www.socomec.com/en/atys-d-m
To download, brochures, catalogues and technical manuals.

Printing informations: 1 color Black. White paper 90g/m².
Printing size: 420x297. Final size 210x297. This page visible first.
A separate sheet for each language.



542 954 B - 06/14 - EN Non contractual document. Subject to change without notice.

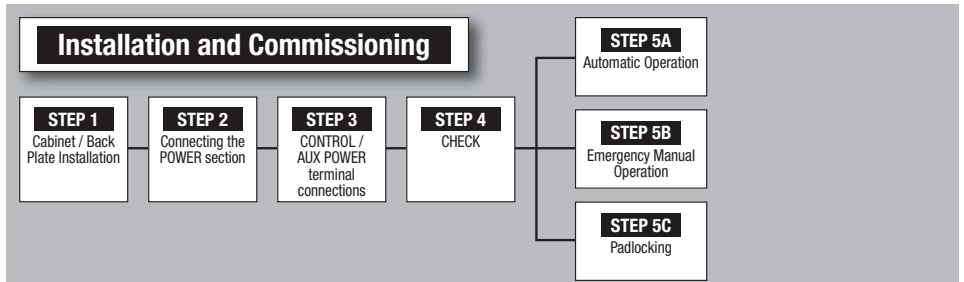

STEP 5B Manual operation

- Open the front cover as shown to put into manual mode.
- Use the handle situated in the front panel under the cover to operate the transfer switch.
- Check the changeover switch position on the indicator before operating.

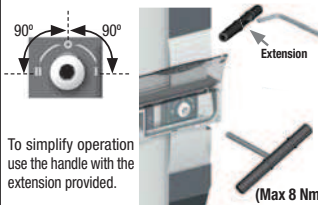

To simplify operation use the handle with the extension provided.

(Max 8 Nm)

STEP 5C Padlocking mode

- In order to padlock put the product in manual mode.
- Pull the locking mechanism and insert a padlock as shown.
- As standard padlocking in the 0 position. Configurable to I-0-II (see step 1).

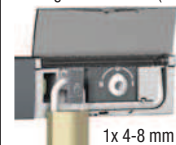

1x 4-8 mm

STEP 4 Check

Whilst in manual mode, check the wiring and if ok power up the product.

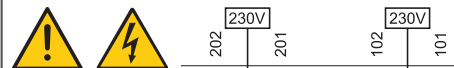

STEP 5A Automatic operation

Close the front cover as shown to put the product into automatic mode. The product is now ready to receive order inputs based on the following logic.

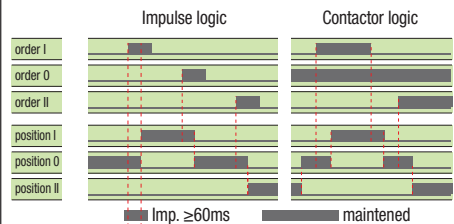

Note: Excludes position switching delays.

For contactor logic bridge contact 313 with 317.

To operate: close the contact corresponding to the desired position.

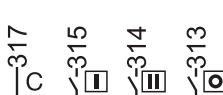

STEP 3

Ensure that the



See ins sheet

Auxiliary con Fitting of the 2nc To fit an AC, the NC changeover c



STEP 1

Installation

Caution: Ensure that the product is installed on a flat rigid surface.

Recommended orientation

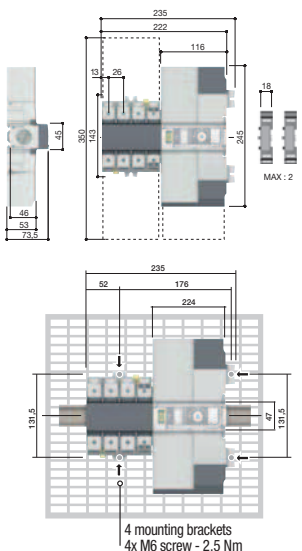
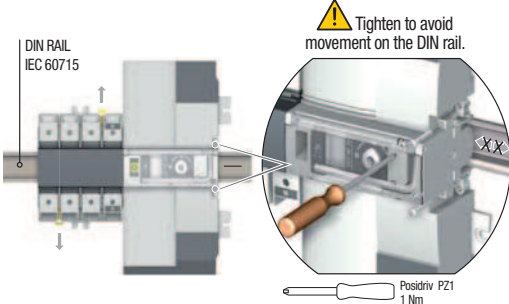
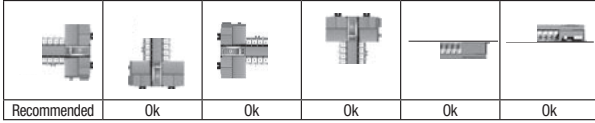

Padlocking configuration

⚠ The ATyS M is delivered with padlocking configured to the 0 position.

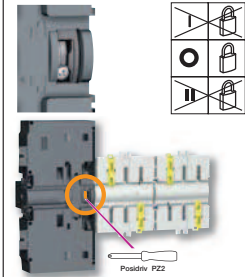

⚠ To allow padlocking in all positions (I - 0 - II), configure the ATyS M as follows before installation. (Screw is located at the back of the product).

STEP 2

Power Terminal Connections

⚠ It is essential to tighten all terminals including those not being used.

Load side bridging bar.
125A: 1309 2006
160A: 1309 2016



Hexagonal Metric Allen size 4
5,0 Nm
10 to 70 mm²
15mm



Voltage taps provide 2x ≤ 1.5mm² connections. They can be fitted in any terminals on the source supply side. Do not use on the load side when equipped with a bridging bar.

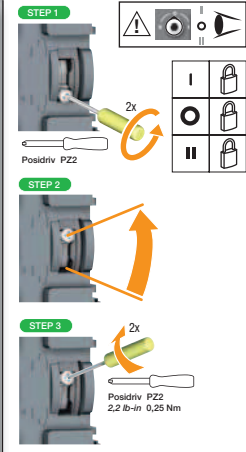
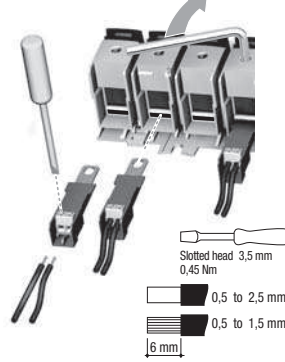

CONTROL / AUX POWER Terminals and wiring

The product is in Manual Mode (front cover open).

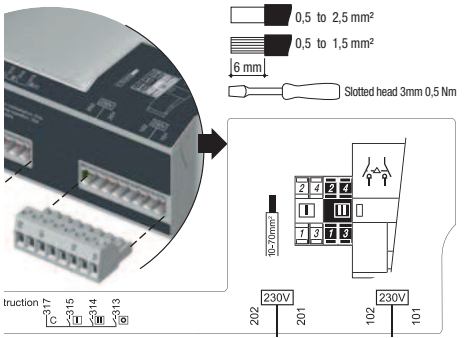

Notes: One module factory fitted (1309 0001). 5 A AC1: 1309 0001 or 1309 0011

switch must first be put in position 0. An auxiliary contact module comprises: one NO/contact for each position (I-0-II). To install use the long screws supplied with the module.

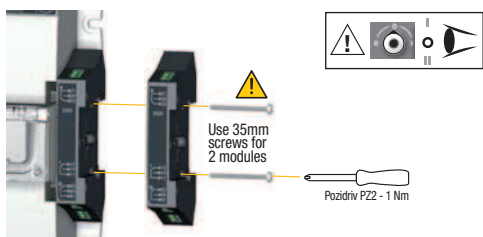

Type	Terminal no.	Description	Characteristics	Recommended connection cross-section
Inputs	101 / 102	Source 1 power supply	220Vac -20% (176Vac) to 240Vac	0,5 to 2,5 mm² (rigid)
	201 / 202	Source 2 power supply	+20% (288Vac) 45 to 65Hz	
	313	Position 0 order if closed with 317. Also allows control logic selection: contactor (always closed) / impulse (close to switch)	Do not connect to any power supply	
	314	Position II order if closed with 317		
	315	Position I order if closed with 317		
317	Common control terminal for 313 to 315			
Auxiliary contacts unit.	11/12/14	Position I	Dry potential free contact 250Vac 5A AC1 24Vdc 2A	0,5 to 1,5mm² (stranded)
	21/22/24	Position II		
	01/02/04	Position 0		

⚠ Control of position I and II have priority on control of position 0.

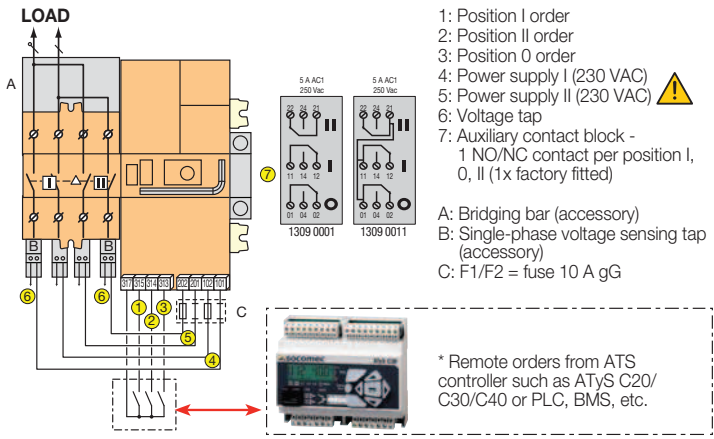

- 1: Position I order
- 2: Position II order
- 3: Position 0 order
- 4: Power supply I (230 VAC)
- 5: Power supply II (230 VAC) ⚠
- 6: Voltage tap
- 7: Auxiliary contact block - 1 NO/NC contact per position I, 0, II (1x factory fitted)

A: Bridging bar (accessory)
B: Single-phase voltage sensing tap (accessory)
C: F1/F2 = fuse 10 A gG

* Remote orders from ATS controller such as ATyS C20/ C30/C40 or PLC, BMS, etc.

3.2. Quick Start ATyS d M (4P)



QUICK START EN 40 - 160A (4P)

ATyS d M

Remotely Operated
Transfer Switching Equipment

Preliminary operations

Check the following upon delivery and after removal of the packaging:

- Packaging and contents are in good condition.
- The product reference corresponds to the order.
- Contents should include:
 - Qty 1 x ATyS M
 - Qty 1 x Emergency handle extension rod
 - Qty 1 x Set of terminals
 - Quick Start instruction sheet

Warning

⚠ Risk of electrocution, burns or injury to persons and / or damage to equipment.

This Quick Start is intended for personnel trained in the installation and commissioning of this product. For further details refer to the product instruction manual available on the SOCOMEC website.

- This product must always be installed and commissioned by qualified and approved personnel.
- Maintenance and servicing operations should be performed by trained and authorised personnel.
- Do not handle any control or power cables connected to the product when voltage may be, or may become present on the product, directly through the mains or indirectly through external circuits.
- Always use an appropriate voltage detection device to confirm the absence of voltage.
- Ensure that no metal objects are allowed to fall in the cabinet (risk of electrical arcing).

Failure to observe good engineering practises as well as to follow these safety instructions may expose the user and others to serious injury or death.

⚠ Risk of damaging the device

- In case the product is dropped or damaged in any way it is recommended to replace the complete product.

Accessories

- Bridging bars 125A or 160A.
- Control voltage transformer (400Vac -> 230Vac).
- Voltage sensing and power supply tap.
- Terminal shrouds.
- Additional aux contact block.
- Polycarbonate enclosure.
- Polycarbonate extension box.
- Dual Power Supply (DPS).
- Power Connection Terminals.
- ATS Control relay ATyS C30 + D10 or D20.
- ATS control relay ATyS C20.
- ATS control relay ATyS C40.



www.socomec.com
www.socomec.com/en/atys-d-m
To download, brochures, catalogues and technical manuals.

Printing informations: 1 color Black. White paper 90g/m².
Printing size: 420x297. Final size 210x297. This page visible first.
A separate sheet for each language.



542 928 B - 06/14 - EN



Non contractual document.
Subject to change without notice.

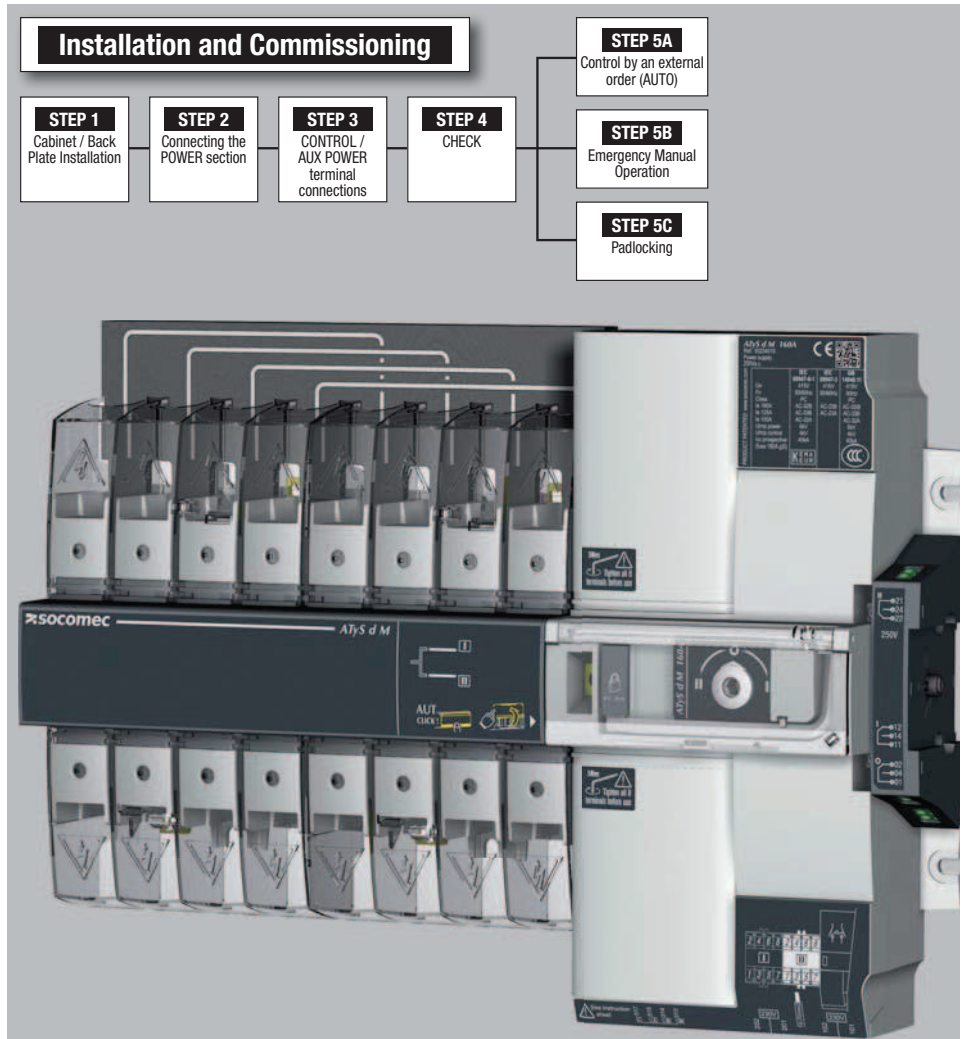

Installation and Commissioning

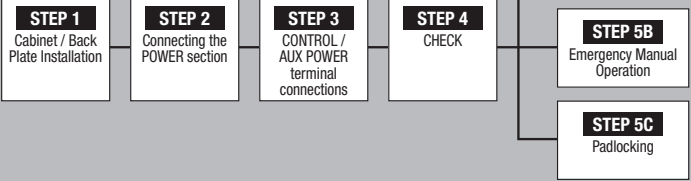

STEP 5B Manual operation

- Open the front cover as shown to put into manual mode.
- Use the handle situated in the front panel under the cover to operate the transfer switch.
- Check the changeover switch position on the indicator before operating.

To simplify operation use the handle with the extension provided.

(Max 8 Nm)

STEP 5C Padlocking mode

- In order to padlock put the product in manual mode.
- Pull the locking mechanism and insert a padlock as shown.
- As standard padlocking in the 0 position. Configurable to I-0-II (see step 1).

1x 4-8 mm

STEP 4 Check

Whilst in manual mode, check the wiring and if ok power up the product.

STEP 5A Automatic operation

Close the front cover as shown to put the product into automatic mode. The product is now ready to receive order inputs based on the following logic.

Note: Excludes position switching delays.

For contactor logic bridge contact 313 with 317.

To operate: close the contact corresponding to the desired position.

STEP 3

Ensure that the...

Auxiliary con...
Fitting of the 2nc...
To fit an AC, the...
one NO/NC chan...
with the module

STEP 1

Installation

Caution: Ensure that the product is installed on a flat rigid surface.

Recommended orientation

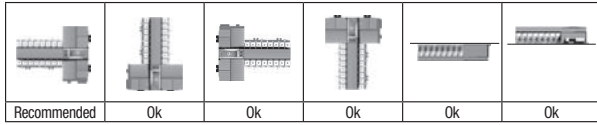

DIN RAIL
IEC 60715

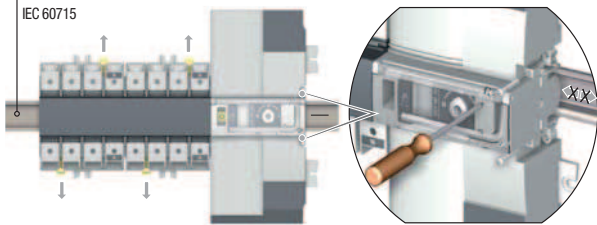

Tighten to avoid movement on the DIN rail.

Posidriv PZ1
1 Nm

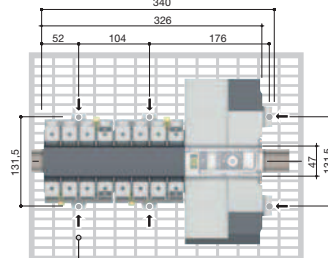
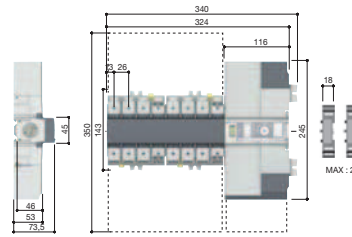

6 mounting brackets
6x M6 screw - 2,5 Nm

Padlocking configuration

The ATyS M is delivered with padlocking configured to the 0 position.

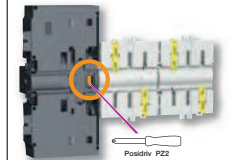
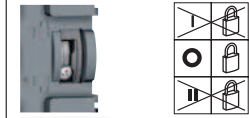

To allow padlocking in all positions (I - 0 - II), configure the ATyS M as follows before installation. (Screw is located at the back of the product).

STEP 2

Power Terminal Connections

It is essential to tighten all terminals including those not being used.



Source supply side

Load side bridging bar.
125A: 1309 4006
160A: 1309 4016

Hexagonal Metric
Allen size 4
5,0 Nm

10 to 70 mm²
15mm

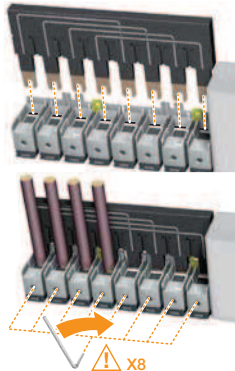

Voltage taps provide 2x ≤ 1.5mm² connections. They can be fitted in any terminals on the source supply side. Do not use on the load side when equipped with a bridging bar.

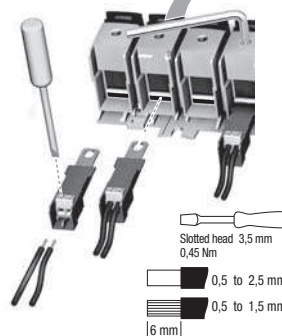

Slotted head 3,5 mm
0,45 Nm

0,5 to 2,5 mm²

0,5 to 1,5 mm²

6 mm

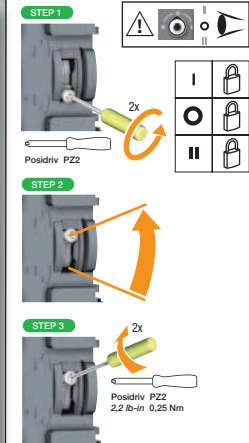

CONTROL / AUX POWER Terminals and wiring

The product is in Manual Mode (front cover open).

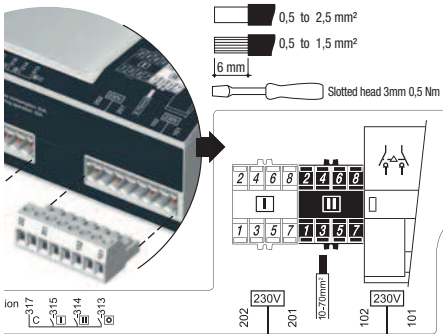

Notes: One module factory fitted (1309 0001).

1AC: 1309 0001 or 1309 0011

switch must first be put in position 0. An auxiliary contact module comprises: governor contact for each position (I-0-II). To install use the long screws supplied

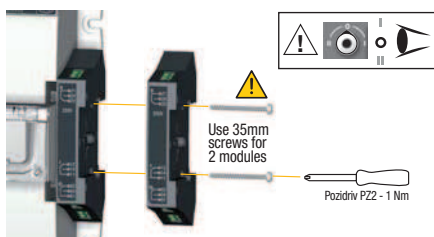

Use 35mm screws for 2 modules

Posidriv PZ2 - 1 Nm

Type	Terminal no.	Description	Characteristics	Recommended connection cross-section
Inputs	101/102	Source 1 power supply	220Vac -20% (176Vac) to 240Vac +20% (288Vac) 45 to 65Hz	0,5 to 2,5 mm ² (rigid) 0,5 to 1,5mm ² (stranded)
	201/202	Source 2 power supply		
	313	Position 0 order if closed with 317. Also allows control logic selection: contactor (always closed) / impulse (close to switch)	Do not connect to any power supply	
	314	Position II order if closed with 317		
	315	Position I order if closed with 317		
	317	Common control terminal for 313 to 315		
Auxiliary contacts unit.	11/12/14	Position I	Dry potential free contact 250Vac 5A AC1 24Vdc 2A	
	21/22/24	Position II		
	01/02/04	Position 0		

Control of position I and II have priority on control of position 0.

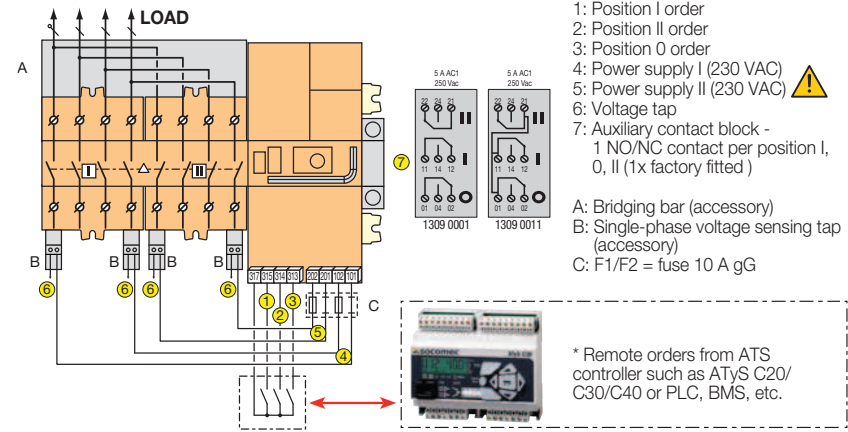

- 1: Position I order
- 2: Position II order
- 3: Position 0 order
- 4: Power supply I (230 VAC)
- 5: Power supply II (230 VAC)
- 6: Voltage tap
- 7: Auxiliary contact block - 1 NO/NC contact per position I, 0, II (1x factory fitted)

- A: Bridging bar (accessory)
B: Single-phase voltage sensing tap (accessory)
C: F1/F2 = fuse 10 A gG

* Remote orders from ATS controller such as ATyS C20/ C30/C40 or PLC, BMS, etc.

4. ATYS D M VERSIONS

The ATyS d M is available as 2P or 4P with the possibility of being used on virtually any open transition type of application that is remotely controlled through external dry contacts.

4.1. Product presentation

This quick-acting source transfer switch incorporates:

1. 2 mechanically interlocked switches.
2. A quick-acting electric control unit enabling electric or manual system operation.
3. A bridging bar (accessory)
4. Electrical specifications compliant with product standards, and a version identification.
5. Changeover switch wiring identification.
6. Connection of control/command circuits.

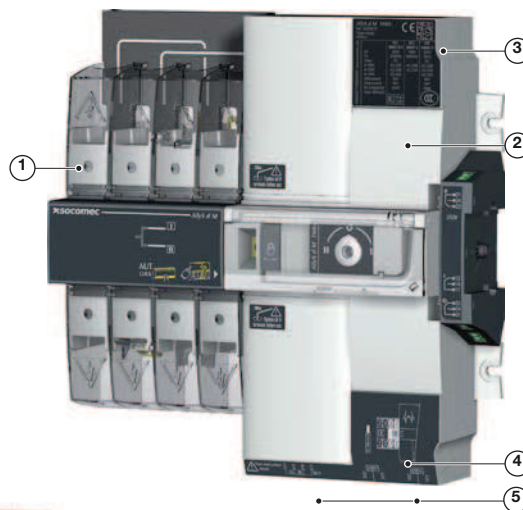

Note: The load may be connected to the top or bottom of the switch with the motorisation preferably on the right hand side as shown.

4.2. Specifications and advantages

1 - Power section:

A fully integrated and interlocked transfer switch, with high electrical performance.







2 - Operation:

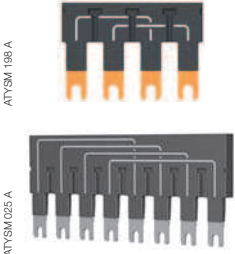

A flexible operating mechanism enabling quick motorised transfer in remote control mode or locally in manual mode for emergency operations. It also features a locking facility to ensure (in the zero position) a secured isolation of the load (padlocked).

4.3. Supply types

The power supply of ATyS d M is to be 220 to 240VAC $\pm 20\%$ (176-288Vac) at a frequency of 50/60 Hz and has been developed so as to meet most network configurations.

5. OPTIONAL ACCESSORIES

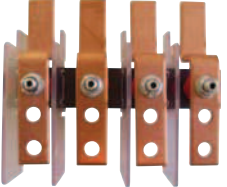
<p>Auxiliary contacts</p>	<p>Each product can take up to 2 auxiliary contact blocks. Each accessory integrates 1 NOC auxiliary contact (for each position I, O and II) 1309 0001 or NONC for 1309 0011.</p> <p>Characteristics: 250 VAC / 5 A maximum. The ATyS d M includes 1x aux contact reference 1309 0001 as standard.</p>		<p>Ref. : 1309 0001 Ref. : 1309 0011</p>
<p>Bridging bars</p>	<p>To provide a common point on the outgoing side of the switch (load side).</p>		<p>Single phase product: Rating ≤ 125A: 1309 2006 Rating 160A: 1309 2016</p> <p>Three phase product: Rating ≤ 125A: 1309 4006 Rating 160A: 1309 4016</p>
<p>Voltage sensing and power supply tap</p>	<p>It allows connection of 2 x 1.5 mm² voltage sensing or power cables. The single-pole voltage sensing tap can be mounted in the terminals without reducing their connecting capacity. Do not use with the bridging bar.</p>		<p>Ref. : 1399 4006 2 parts/ref.</p>
<p>Terminal shrouds</p>	<p>Protection against direct contact with terminals or connecting parts. Other features: Perforations allowing remote thermographic inspection without removal. Possibility of sealing. Not for use on terminals with bridging bars fitted.</p>		<p>Ref. : 2294 4016 2 parts/ref.</p>
<p>Double power supply - DPS</p>	<p>Allows an ATyS d M to be supplied by two 230 Vac 50/60 Hz networks.</p>		<p>Ref. : 1599 4001</p>
<p>Enclosure</p>	<p>Fully dedicated to ATyS M use, this polycarbonate enclosure provides easy access to a compact, enclosed transfer switch (HxWxD: 385x385x193mm).</p>		<p>Ref. : 1309 9006</p>
<p>Extension unit</p>	<p>Combined with the polycarbonate enclosure, the extension box creates extra space for routing cables with a larger diameter.</p>		<p>Ref. : 1309 9007</p>
<p>Single phase residential enclosure</p>	<p>Dedicated to the implementation of a single-phase ATyS M, it enables easy access to a compact power supply switching solution. 40-160A (HxWxD: 410x305x150mm). IP41</p>		<p>Ref. : 1309 9056</p>

Auto-transformer	For use with ATyS M in 400 VAC three-phase applications without a distributed neutral. As the ATyS M has a 230Vac auxiliary power supply requirement. When no neutral connection is available this autotransformer (400/230 VAC, 400 VA) provides the 230 VAC required for the ATyS M to function.		Ref. : 1599 4121
Power connection terminals	The power connection terminals allow conversion of the cage terminals into bolt-on type connection terminals, enabling connection of up to two 35mm ² cables or one 70mm ² cable. Each power connection terminal is provided with separation screens.		Ref. : 1399 4017 For complete conversion, order 3 times the reference.
Control relays	ATyS C30 and C40 devices are modular, din rail mounted ATS controllers designed for use with products such as the ATyS d M motorised changeover switch. For further details refer to the SOCOMEC General Catalogue.		ATyS C30 Supplied from measurement circuit: reference 1599 3030 or DC power supply: reference 1599 3031 ATyS C40 DC power supply: for Gen/Gen applications: reference 1599 3040
Remote control interfaces D10/D20 (for use with ATyS d M + ATyS C30 only)	<ul style="list-style-type: none"> - Use. Adapted to applications requiring the changeover switch to be fitted inside the cabinet. Product self-supplied via the RJ45 connection lead with ATyS M. Maximum connection distance: 3 m. - D10. For transferring source and changeover switch statuses to the cabinet front panel. IP rating: IP21. - D20. In addition to the D10 interface functions, enables configuration, checking, tests and measurements display. IP rating: IP21. - Door mounted. 2 holes, ø 22.5. Connection to ATyS M via the Socomec 1599 2009 connection cable. 		Ref. D10: 1599 2010 Ref. D20: 1599 2020

6. TECHNICAL DATA

Ratings		40A	63 A	80 A	100 A	125 A	160 A
Frequencies		50/60 Hz	50/60 Hz	50/60 Hz	50/60 Hz	50/60 Hz	50/60 Hz
Thermal current I _{th} at 40 °C (A)		40	63	80	100	125	160
Thermal current I _{th} at 50 °C (A)		40	63	80	100	110*	125
Thermal current I _{th} at 60 °C (A)		40	50	63	80	100*	125
Thermal current I _{th} at 70 °C (A)		40	40	50	63	80*	100
Rated insulation voltage U _i (V) (Power circuit)		600	600	600	600	600	600
Rated impulse withstand voltage U _{imp} (kV) (power circuit)		6	6	6	6	6	6
Rated insulation voltage U _i (V) (control circuit)		300	300	300	300	300	300
Rated impulse withstand voltage U _{imp} (kV) (control circuit)		4	4	4	4	4	4
Rated operational currents (A) IEC 60947-3 at 415VAC at 40 °C	AC 21A / 21 B	40/40	63/63	80/80	100/100	125/125	160/160
	AC 22A / 22 B	40/40	63/63	80/80	100/100	125/125	125/160
	AC 23A / 23 B	40/40	63/63	80/80	100/100	125/125	125/160
Rated operational currents (A) IEC 60947-6-1 415Vac at 40 °C	AC 33B / AC32B **AC 33iB	40/40	63/63	80/80	100/100	125/125	125**/160
Fuse protected short-circuit withstand if using gG DIN fuses	Fuse protected short-circuit withstand (kA eff)	50	50	50	50	50	40
	Associated fuses (gG DIN)	40	63	80	100	125	160
Short-circuit capacity	Rated short-term withstand current: I _{cw} 1s (kA eff)	4	4	4	4	4	4
	Rated short-term withstand current: I _{cw} 30ms (kA eff)	10	10	10	10	10	10
Switching time at I _n excluding loss of supply sensing time and excluding any delay timers applicable.	I-II or II-I (ms)	180	180	180	180	180	180
	Duration of "electrical blackout" at U _n (ms)	90	90	90	90	90	90
	I-O / O-I / II-O / O-II (ms)	45	45	45	45	45	45
Consumption	Inrush current(A)	20	20	20	20	20	20
	Consumption in stabilised state (VA)	6	6	6	6	6	6
Mechanical characteristics	Number of changeovers	10000	10000	10000	10000	10000	10000
Connection cross-section (⚠ not compatible with aluminium cables)	Minimum size (Cu mm ²), flexible and rigid	10	10	10	10	10	10
	Maximum size (Cu mm ²), flexible and rigid	70	70	70	70	70	70
Equipment class (According to IEC 60947-6-1)		PC	PC	PC	PC	PC	PC
EMC environment		A	A	A	A	A	A

* Possibility of reaching 125A with bigger connection cross-sections and use of the 160A bridging bar.

** AC 33iB 160A according to GB 14048.11.



This is a class A product. In a domestic environment, this product may cause radio interference in which case the user may be required to take adequate measures.

7. ENVIRONMENTAL CONDITIONS



Humidity

- 80 % humidity without condensation at 55 °C
- 95 % humidity without condensation at 40 °C



Temperature

- -20 +40 °C without de-rating
- 40 °C < t ≤ 70 °C with de-rating (see Technical Characteristics)



Altitude

- Max 2000 m without de-rating

Correction factors:

	2 000 m < A ≤ 3 000 m	3 000 m < A ≤ 4 000 m
UE	0.95	0.80
le	0.85	0.85



Storage

- 1 year maximum
- Maximum storage temperature: +55 °C



IP rating

- IP41 in the SOCOMEC polycarbonate modular enclosure
- IP2x for non-enclosed modular product

Protection class: Class 1

8. PRODUCT INSTALLATION



Prior to installation of the product ensure that the padlocking setting screw (located at the back of the product) is configured as per your requirements.
For locking in Positions I, II and 0, refer to the following procedure

8.1. Changing the padlocking configuration

To configure the locking in the 3 positions:

STEP1: loosen the screw at the back of the product as shown below.

STEP2: slide the screw upwards.

STEP3: tighten the screw in the top position as shown.

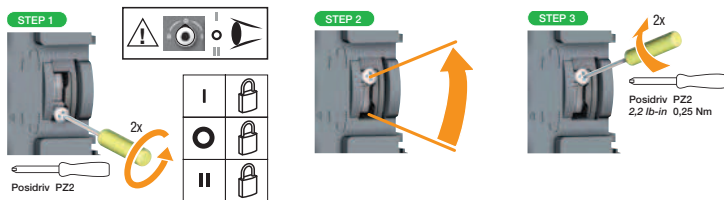
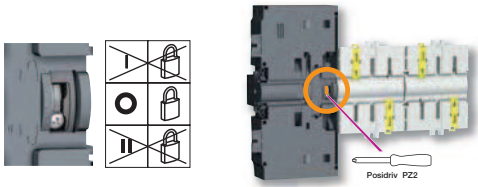

8.2. Recommended orientation

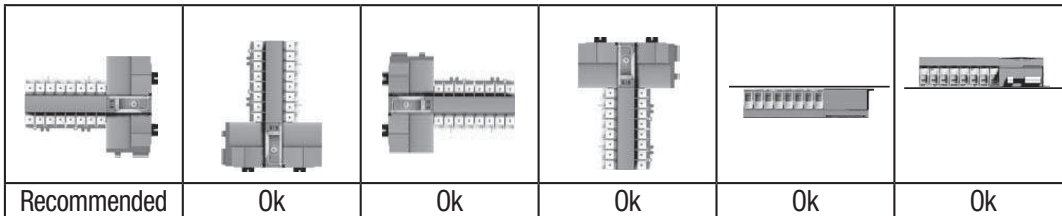

8.3. Dimensions of the single phase product

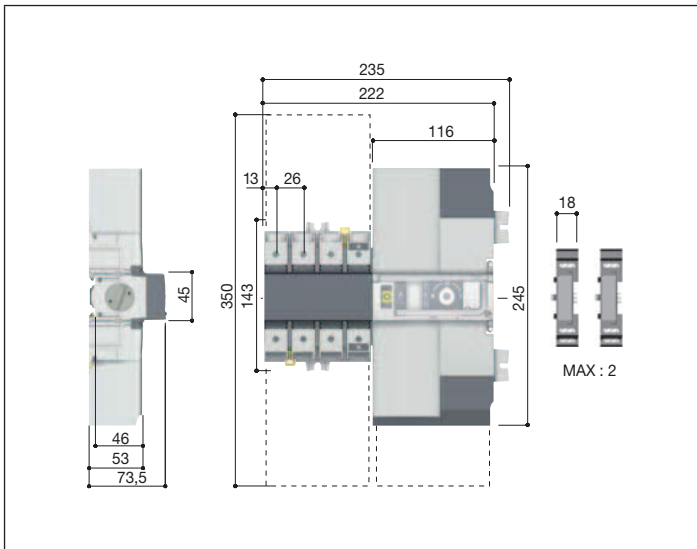

8.4. Back plate mounted single phase product

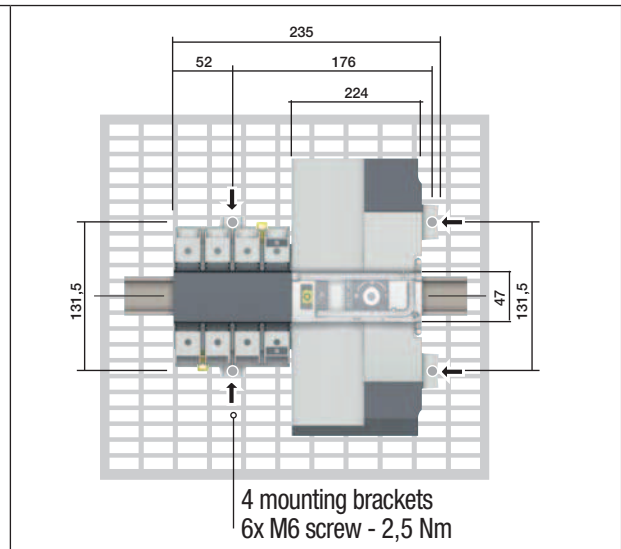

8.5. Dimensions of the three phase product

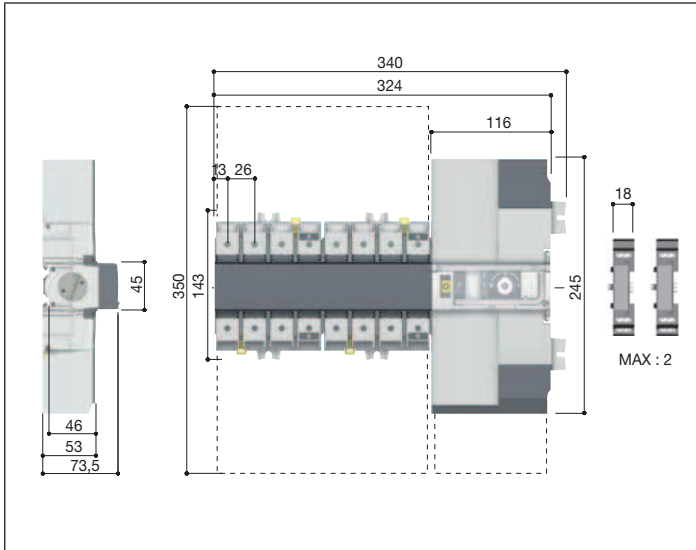

8.6. Back plate mounted three phase product

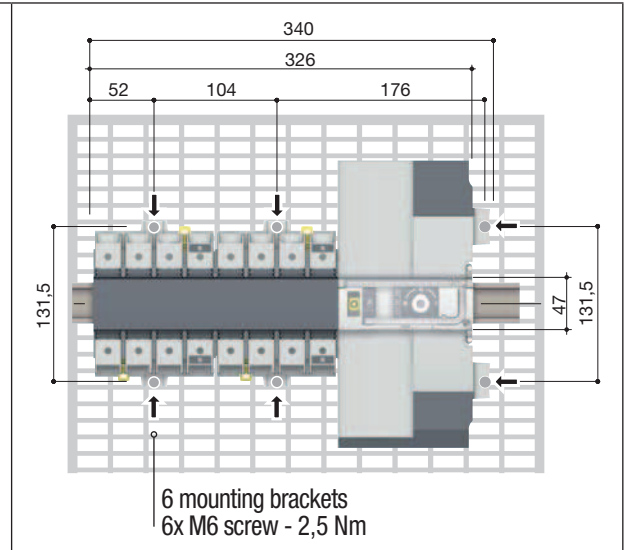

8.7. DIN rail mounted

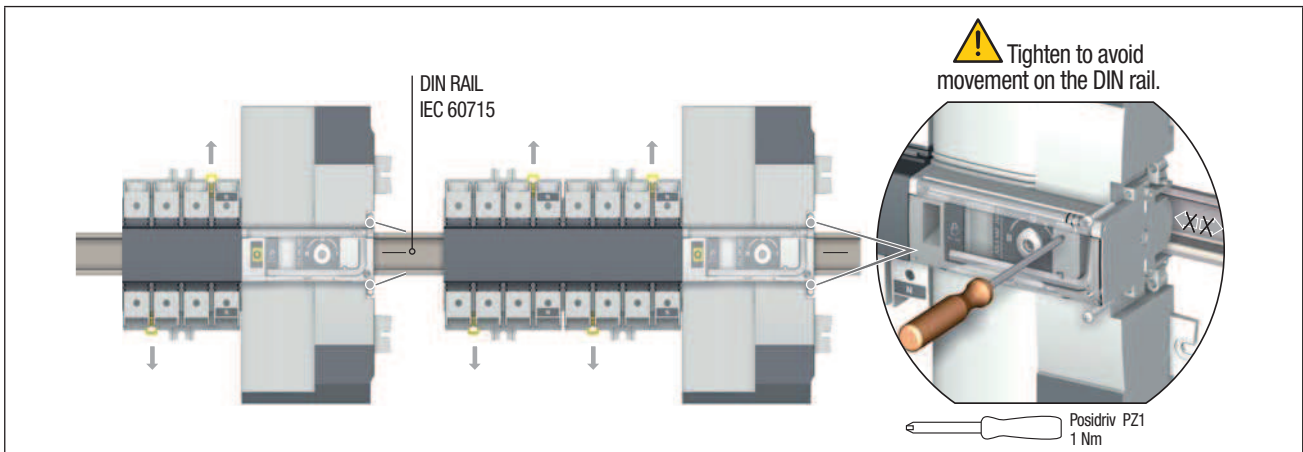

9. INSTALLATION OF OPTIONAL ACCESSORIES

9.1. Auxilliary contacts

Ref. 1309 0001 or ref. 1309 0011.

To fit an additional AC, the switch must first be put in the 0 position. An auxiliary contact module comprises: one NO/NC or NOC changeover contact for each position (I-0-II). To install use the screws supplied with the module. One module is factory fitted.

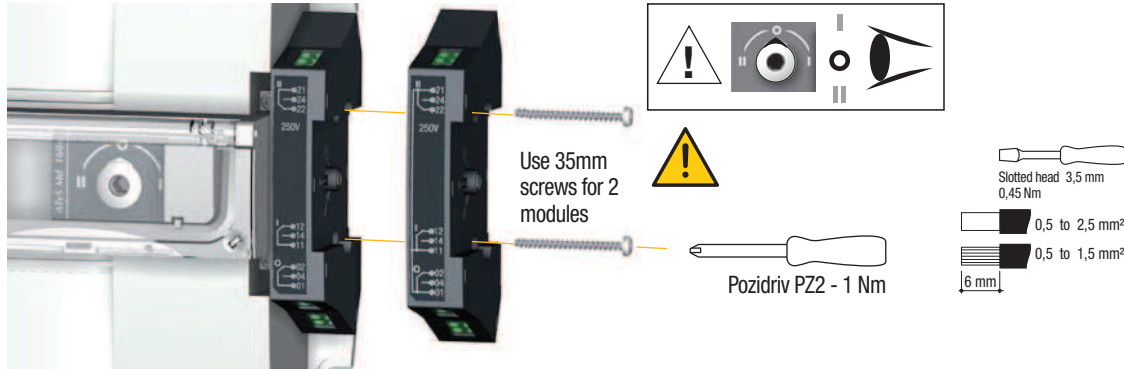

9.2. Voltage sensing and power supply tap

Ref. 1399 4006.

This provides 2 connection terminals for conductors with cross-section $\leq 1.5 \text{ mm}^2$.

The single pole terminals can be fitted in any of the terminal cages without reducing the cage connection capacity. 2 parts/ref. Do not use in case of use of the bridging bar.

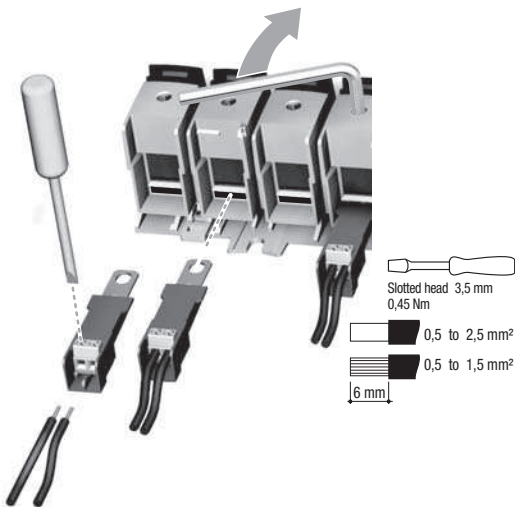

9.3. Bridging bars 2P

Ratings $\leq 125\text{A}$: ref. 1309 2006; 160A: ref. 1309 2016



There are two references available: one for ratings up to 125A, and another rated at 160A. On the ATyS d M the bridging bar (load side) may be fit to either side of the product (top or bottom).

9.4. Bridging bars 4P

Ratings $\leq 125\text{A}$: ref. 1309 4006; 160A: ref. 1309 4016

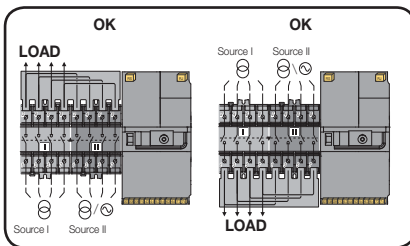

Bridging bar.
125A: 1309 4006
160A: 1309 4016

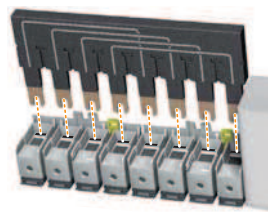

Hexagonal Metric
Allen size 4
5,0 Nm

10 to 70 mm²

15mm

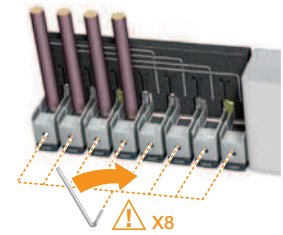

There are two references available: one for ratings up to 125A, and another rated at 160A. On the ATyS d M the bridging bar (load side) may be fit to either side of the product (top or bottom).

9.5. Terminal shrouds

Ref. 2294 4016

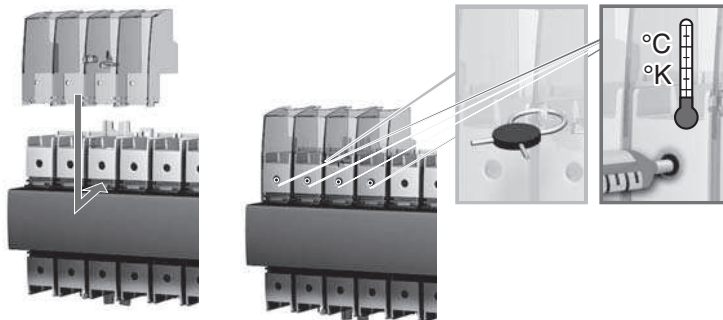

10. INSTALLING WITHIN THE ATYS M ENCLOSURE

10.1. Modular plastic enclosure

Ref. 1309 9056

Dimensions and mounting (for 2P ATyS M products only)

The enclosure must be wall-mounted using screws (not supplied). Recommended size: M6 50 mm (minimum).
Weight: between 8 and 10 kg, depending on the accessories.



Only 1 aux contact block may be installed when using this enclosure.

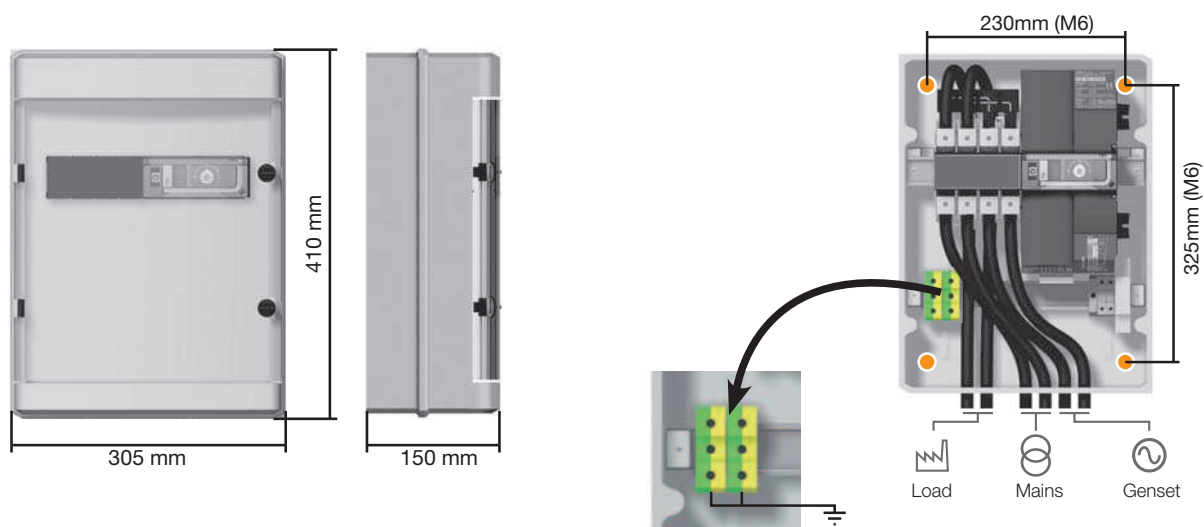

10.2. Polycarbonate enclosure

Ref. 1309 9006

Dimensions and mounting

The enclosure must be wall-mounted using screws (not supplied). Recommended size: M6 50 mm (minimum).
Weight: between 8 and 10 kg, depending on the accessories.



Only 1 aux contact block may be installed when using this enclosure.

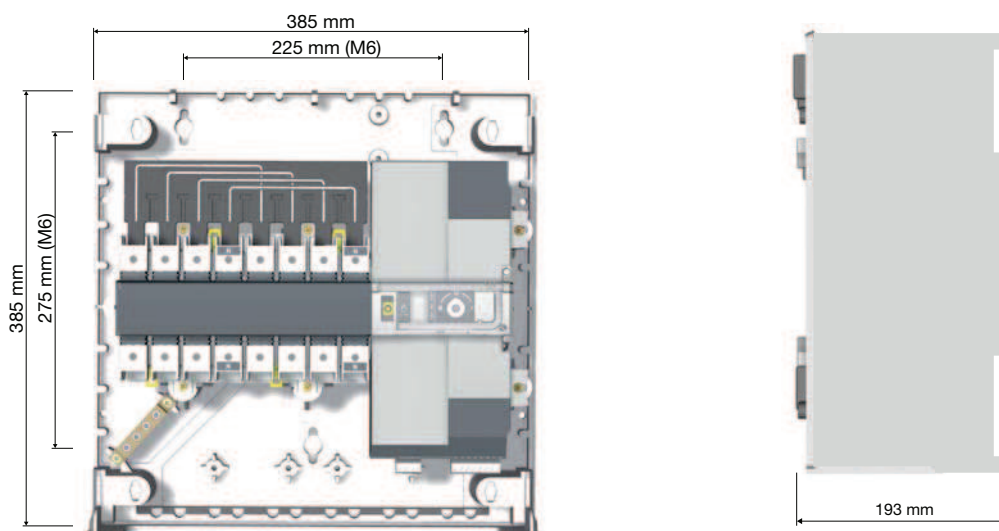

10.2.1. Wiring in a polycarbonate enclosure



Example: Neutral on the right

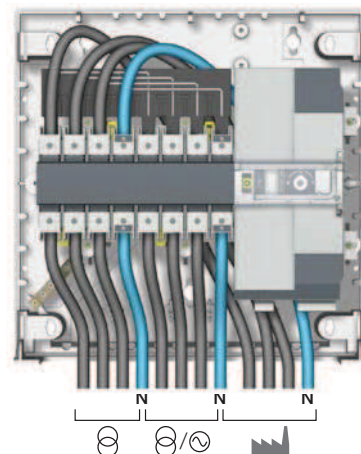

Max cable size 25 mm²

10.2.2. Extension unit

Ref. 1309 9007



Enables you to allocate additional space to the polycarbonate enclosure (ref. 1309 9006).

11. CONNECTION OF THE POWER CIRCUITS

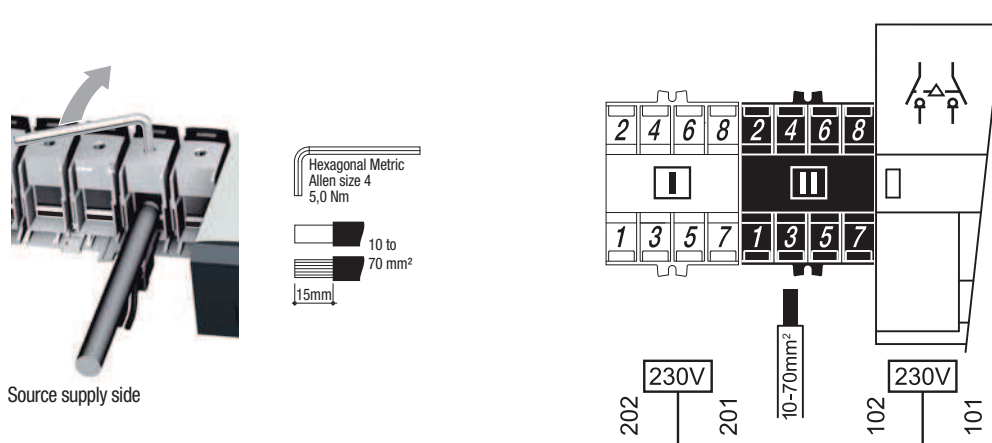

It is essential to tighten all terminals (even those that are not used).

11.1. Ratings / cross-sections table of correspondence

	40 A	63 A	80 A	100 A	125 A	160 A
Min cable size recommended (mm ²)	10	16	25	35	50	50
**Max cable size recommended (mm ²)	50	50	50	50	70*	70*

*With extension unit.

** Maximum cable size for rigid cable is 50 mm². For larger terminations use the power connection terminals ref. 1399 4017.



Not compatible with aluminium cables

11.2. Parallel pole set-up for a 4P device used in single phase

Rating conversion table for use in single phase and two-by-two parallel pole set up.
(Max ambient temperature = 40 °C).

Nominal current rating in three-phase (A)	Nominal current rating in single-phase (2 poles in //) (A)
40	63
63	100
80	125
100	160
125	200
160	250

12. CONNECTION OF CONTROL/COMMAND CIRCUITS



Switch to manual mode before connecting the product. (Front Auto/Manu cover open). The product is delivered in the 0 position. The bridging bar may either be fit to top or bottom of the product.

LOAD SIDE

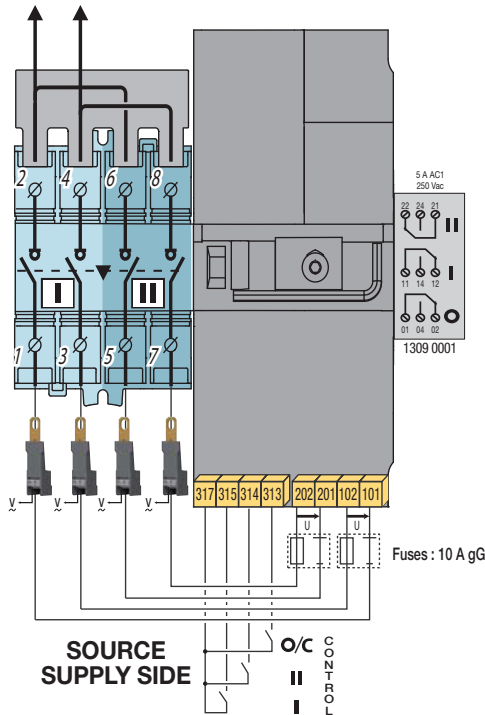

LOAD SIDE

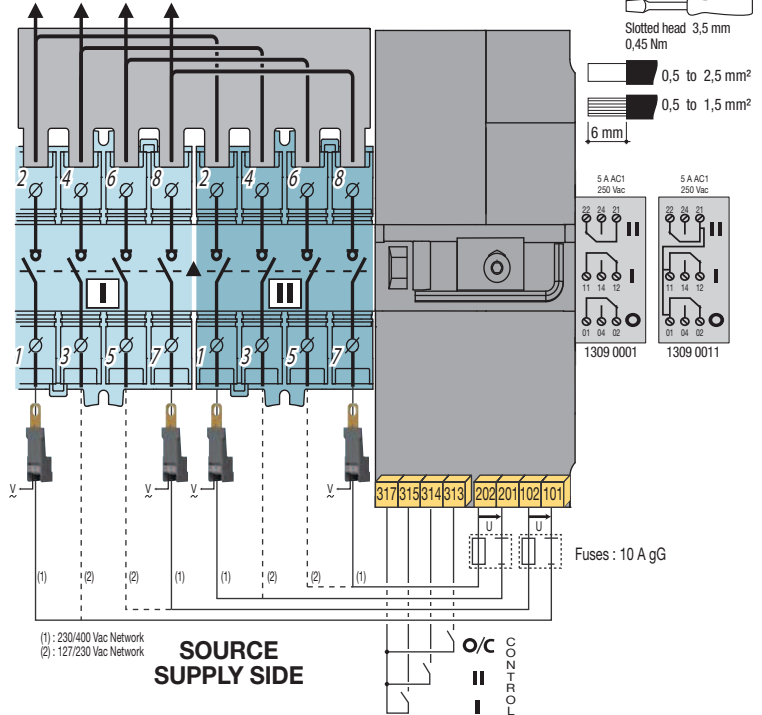

- 0,5 to 2,5 mm²
- 0,5 to 1,5 mm²
- 6 mm
- Slotted head 3mm 0,5 Nm

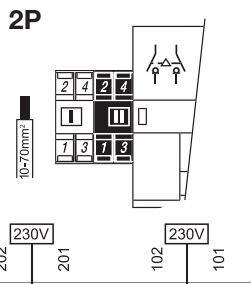

All pressure on the connector pins is to be avoided during wiring of the auxiliary cables



The product is delivered in the 0 position and in auto mode. Maximum control cables length = 10 m. In case of longer distance, use control relays.

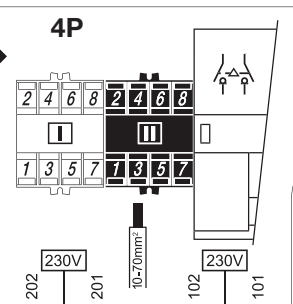

Ensure that the product is in Manual Mode (front cover open).



12.1. Terminal connectors designation

Type	Terminal no.	Description	Characteristics	Recommended connection cross-section
Inputs	101/102	Source 1 power supply	220Vac -20% (176Vac) to 240Vac +20% (288Vac) 45 to 65Hz Do not connect to any power supply	0,5 to 2,5 mm ² (rigid) 0,5 to 1,5mm ² (stranded)
	201/202	Source 2 power supply		
	313	Position 0 order if closed with 317 ⁽¹⁾ . Also allows control logic selection: contactor (always closed) / impulse (close to switch)		
	314	Position II order if closed with 317		
	315	Position I order if closed with 317		
	317	Common control terminal for 313 to 315		
Auxiliary contacts unit.	11/12/14	Position I	Dry potential free contact 250Vac 5A AC1 24Vdc 2A	
	21/22/24	Position II		
	01/02/04	Position 0		



⁽¹⁾ Control of position I and II have priority on control of position 0.

12.2. Auxiliary contact operating schedule

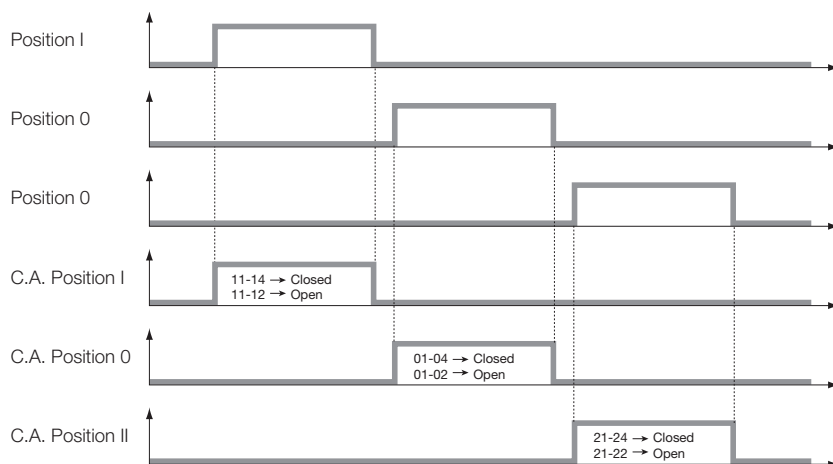

13. OPERATION

13.1. Presentation of the product interface

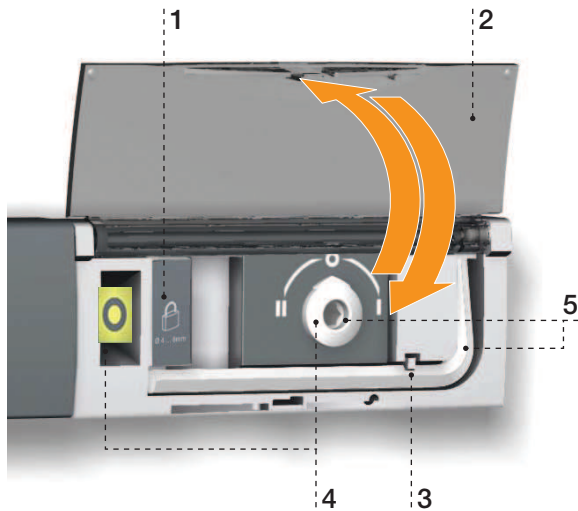

1. Locking

- Option to padlock using a 1 x 8 mm max. padlock.

2. AUT/MAN cover

- Open the cover to switch to manual mode.
- Close the cover to return to automatic (remote control) mode.
- Open and close the cover to clear faults.

3. Auto/Manual mode sensor

4. Switch position indicators

- Display of position I, 0, II.

5. Manual switching

- Insert the Allen key (5.0 mm) provided and turn to switch manually.
- Manual operation is not possible when padlocked.

13.1.1. Reset

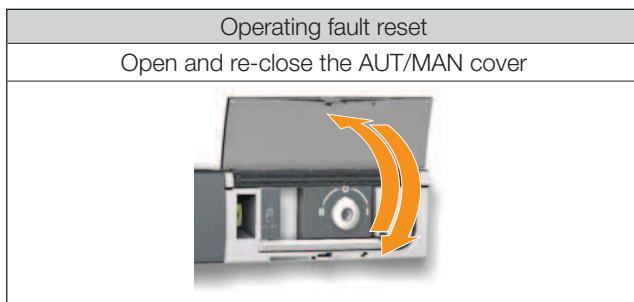

13.2. Manual mode

To access manual mode, open the Aut/Man cover.

Once manual mode is active (cover open) it is possible:

- To lock the changeover switch (padlock).
- To manually operate the changeover switch using the handle.



As soon as manual mode is activated, remote orders are inhibited

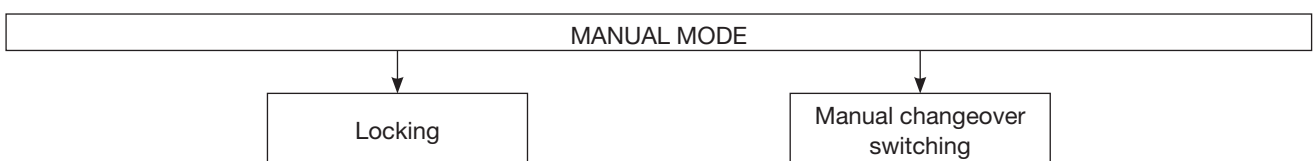

13.2.1. Manual switching

Use the handle situated on the front panel under the cover to manoeuvre the changeover switch. To simplify the operation, it is advised to also use the handle extension that is delivered with the product.

Check the changeover switch position on the indicator situated on the front panel before making any operation.

- From position I, turn anti-clockwise to get to position 0
- From position 0, turn anti-clockwise to get to position II
- From position II, turn clockwise to get to position 0
- From position 0, turn clockwise to get to position I



Do not force the product (Max 8 Nm).

13.3. Padlocking

Enables locking in the 0 position (factory configuration) or in positions I, 0 or II (user configurable).

It is necessary to configure padlocking to all positions before installation as access to configuration is at the back of the product. Refer to section 8.1. Changing the padlocking configuration, page 21

Locking is only possible in manual mode (cover open).

Pull on the locking handle to enable the interlock. Lock by inserting a padlock into the orifice provided for this purpose.

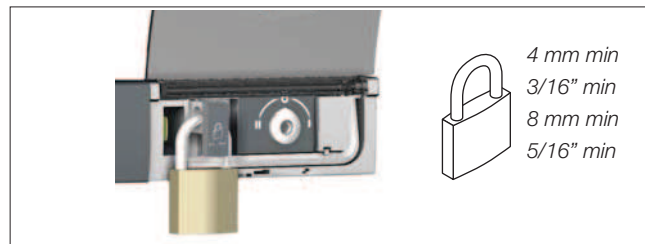

13.4. Commissioning / Putting into service

Whilst in manual mode check the wiring and installation. If ok power up the product. This product must always be put into service by qualified and approved personal.

13.5. Automatic (remote) mode

Close the cover to enter automatic mode. Make sure that the changeover switch is in automatic mode (AUT LED lit).

13.5.1. Sealable Auto/Manual cover

Auto/Manu mode can be protected by sealing the standard Auto/Manu cover as shown.

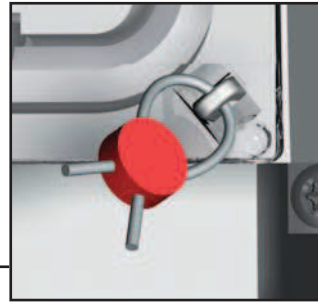

13.6. Possible actions

Once in automatic mode, it is possible to:

- Receive remote order inputs based on impulse or contactor logic.

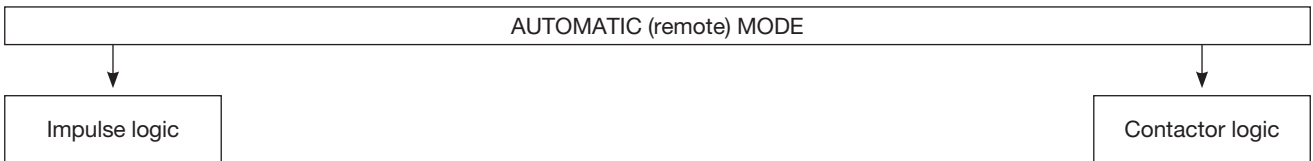

13.6.1. Control logic

13.6.1.1. Impulse logic

(Terminal O/C not connected: terminals 313/317 opened; driven when needed)

<p>Impulse logic:</p> <p>The ATyS is driven to a stable position (I – O – II) after receiving an impulse order.</p> <ul style="list-style-type: none"> • A switching command of at least 60 ms is necessary to initiate the switching operation. • Orders I and II have priority over order 0. <p>Note: The logic diagrams exclude the transfer times.</p>	<p style="text-align: center;">Impulse logic</p> <p style="text-align: center;">Imp. $\geq 60\text{ms}$</p> <p>(Note : Excludes position switching delays)</p>
---	--

13.6.1.2. Contactor logic

(Terminal O/C not connected: terminals 313/317 closed; position 0 control maintained)

<p>Contactor Logic :</p> <p>The ATyS is driven to a specific position (I or II) for as long as the order is maintained.</p> <ul style="list-style-type: none"> • Order O is maintained. (Bridge 313 – 317) • Orders I and II have priority over order 0. • Orders I and II have equal priority. (1st order received is held until no longer maintained). • If order I or II disappears, the device returns to zero position. (With the power supply available). 	<p style="text-align: center;">Contactor logic</p> <p style="text-align: center;">maintained</p> <p>(Note : Excludes position switching delays)</p>
--	--

13.6.2. Positions that can be reached depending on the available source

	ON	ON	ON	ON
	ON OR ON	ON OR ON	ON OR ON	ON OR ON

This table shows the sources that have to be available to enable the transfers. The use of the DPS (Double supply) enables all the transfers independently of the available source.



The ATyS d M includes a Dual Power Supply. (Capable to transfer to the available source with that source available only). For full DPS functionality add a DPS reference 1599 4001 as shown above.

14. PREVENTATIVE MAINTENANCE

It is recommended to operate the product at least once a year.

I - O - II - O - I

Note: Maintenance should be planned carefully and carried out by qualified and authorised personnel. Consideration of the critical level and application where the product is installed should form an essential and integral part of the maintenance plan. Good engineering practice is imperative whilst all necessary precautions must be taken to ensure that the intervention (whether directly or indirectly) remains safe in all aspects.



The use of any Megohmmeter is prohibited on this product as the connection terminals are intrinsically connected to the sensing circuit.

15. TROUBLESHOOTING GUIDE

15.1. Fault finding

When the product does not respond to electrical orders:

- 1) Check the auxilliary voltage supply
- 2) Check the commands (only one command I or II)
- 3) Check that the Auto/Manu cover is closed properly
- 4) Open and close the Auto/Manu cover to reset the system

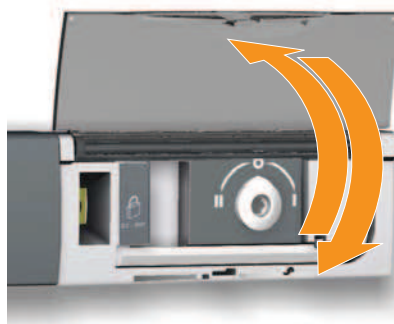

Open and re-close the Auto/Manu cover

15.2. Troubleshooting

Symptoms	Actions to be carried out	Expected results
The product is not functioning	Check for a voltage of 161 to 299 Vac on the supply terminals: <i>101 - 102 and 201 - 202</i>	The voltage is available and within limits
The product does not switch over	Check that the product is not in manual mode: - Automatic mode = Cover closed - Manual mode = Cover open	The product becomes operational
The product cannot be switched over using the handle	Check the direction of rotation of the handle: - Manual switchover from position 1 to position 2 is executed clockwise - The return operation is executed anticlockwise	The product can be switched over using the handle
	Check that the product is not padlocked	
	Use the handle extension on the ALLEN key to check that the appropriate adjustment torque is applied.	
	When using a single auxilliary contact, check that the length of the screws used is not greater than 20 mm	
AUTOMATIC mode is not activated even though the cover is closed	Check that the plastic pin is in place and hitting the sensor on the bottom of the cover This pin activates the sensor which indicates the position of the cover (open or closed)	The product accepts position orders
The product cannot be locked	Check the mechanical position of the changeover switch: - Locking is only possible in position 0 as standard - Locking in positions 1-0-2 is possible by modifying the product in accordance with the instructions	Locking is possible

Socomec worldwide

IN EUROPE

BELGIUM

Critical Power / Power Control & Safety /
Energy Efficiency / Solar Power
Tel. +32 2 340 02 30
Fax +32 2 346 28 99
info.be@socomec.com

FRANCE

Critical Power / Power Control & Safety /
Energy Efficiency / Solar Power
Tel. +33 1 45 14 63 00
Fax +33 1 48 67 31 12
dcm.ups.fr@socomec.com

GERMANY

Critical Power
Tel. +49 621 71 68 40
Fax +49 621 71 68 444
info.ups.de@socomec.com
Power Control & Safety / Energy Efficiency
Tel. +49 7243 65292 0
Fax +49 7243 65292 13
info.scp.de@socomec.com

ITALY

Critical Power
Tel. +39 02 98 242 942
Fax +39 02 98 240 723
info.ups.it@socomec.com
Power Control & Safety / Energy Efficiency
Tel. +39 02 98 49 821
Fax +39 02 98 24 33 10
info.scp.it@socomec.com
Solar Power
Tel. +39 0444 598611
Fax +39 0444 598627
info.solar.it@socomec.com

NETHERLANDS

Critical Power / Power Control & Safety /
Energy Efficiency / Solar Power
Tel. +31 30 760 0900
Fax +31 30 637 2166
info.nl@socomec.com

POLAND

Critical Power / Solar Power
Tel. +48 22 825 73 60
Fax. +48 22 825 73 70
info.ups.pl@socomec.com
Power Control & Safety / Energy Efficiency
Tel. +48 91 442 64 11
Fax +48 91 442 64 19
info.scp.pl@socomec.com

PORTUGAL

Critical Power / Power Control & Safety /
Energy Efficiency / Solar Power
Tel. +351 261 812 599
Fax +351 261 812 570
info.ups.pt@socomec.com

ROMANIA

Critical Power / Power Control & Safety /
Energy Efficiency / Solar Power
Tel. +40 21 319 36 88
Fax +40 21 319 36 89
info.ro@socomec.com

RUSSIA

Critical Power / Power Control & Safety /
Energy Efficiency / Solar Power
Tel. +7 495 775 19 85
Fax +7 495 775 19 85
info.ru@socomec.com

SLOVENIA

Critical Power / Power Control & Safety /
Energy Efficiency / Solar Power
Tel. +386 1 5807 860
Fax +386 1 561 11 73
info.si@socomec.com

SPAIN

Critical Power / Power Control & Safety /
Energy Efficiency / Solar Power
Tel. +34 93 540 75 75
Fax +34 93 540 75 76
info.es@socomec.com

TURKEY

Critical Power / Power Control & Safety /
Energy Efficiency / Solar Power
Tel. +90 216 540 71 20-21-22
Fax +90 216 540 71 27
info.tr@socomec.com

UNITED KINGDOM

Critical Power
Tel. +44 1285 863 300
Fax +44 1285 862 304
info.ups.uk@socomec.com
Power Control & Safety / Energy Efficiency
Tel. +44 1462 440 033
Fax +44 1462 431 143
info.scp.uk@socomec.com

IN ASIA PACIFIC

AUSTRALIA

Critical Power / Power Control & Safety
Tel. +61 2 9325 3900
Fax +61 2 9888 9544
info.ups.au@socomec.com

CHINA

Critical Power / Power Control & Safety /
Energy Efficiency
Tel. +86 21 52 98 95 55
Fax +86 21 62 28 34 68
info.cn@socomec.com

INDIA

Critical Power / Power Control & Safety /
Energy Efficiency / Solar Power
Tel. +91 44 39215400
Fax +91 44 39215450 & 51
info.in@socomec.com

SINGAPORE

Critical Power / Power Control & Safety /
Energy Efficiency
Tel. +65 6506 7600
Fax +65 64 58 7377
info.sg@socomec.com

THAILAND

Critical Power
Tel. +66 2 941 1644 7
Fax +66 2 941 1650
info.ups.th@socomec.com

IN MIDDLE EAST

UNITED ARAB EMIRATES

Critical Power / Power Control & Safety /
Energy Efficiency / Solar Power
Tel. +971 4 29 98 441
Fax +971 4 29 98 449
info.ae@socomec.com

IN AMERICA

USA, CANADA & MEXICO

Power Control & Safety / Energy Efficiency
Tel. +1 617 245 0447
Fax +1 617 245 0437
info.us@socomec.com

OTHER COUNTRIES

NORTH AFRICA

Algeria / Morocco / Tunisia
info.naf@socomec.com

AFRICA

Other countries
info.africa@socomec.com

SOUTH EUROPE

Cyprus / Greece / Israel / Malta
info.se@socomec.com

SOUTH AMERICA

Tel. +34 93 540 75 75
info.es@socomec.com

MORE DETAILS

www.socomec.com/worldwide

HEAD OFFICE

SOCOMECS GROUP

SAS SOCOMECS capital 10 816 800€
R.C.S. Strasbourg B 548 500 149
B.P. 60010 - 1, rue de Westhouse
F-67235 Benfeld Cedex - FRANCE
Tel. +33 3 88 57 41 41
Fax +33 3 88 74 08 00
info.scp.isd@socomec.com

www.socomec.com

YOUR DISTRIBUTOR

